



Contents

<i>Included Parts List</i>	3
<i>Drivetrain Requirements</i>	4
<i>Additional Parts</i>	4
<i>Important Safety & Emissions Information</i>	5
<i>Component Instructions & Guidelines</i>	10
<i>Evaporative Emissions Control (EVAP) System Install</i>	14
<i>Catalytic Converters</i>	15
<i>Engine Connections</i>	16
<i>Break-In/Maintenance</i>	31
<i>Troubleshooting</i>	35



Included Parts List

Part Description	6.4L Part Number	Service Parts	Quantity
PACKAGE	77072451AG		
Catalytic Converter – Right	68281724AA	Yes	1
Catalytic Converter – Left	68281725AA	Yes	1
Purge Valve	04627694AB	Yes	1
Charcoal Canister	05147158AA	Yes	1
Accelerator Pedal	04861714AF	Yes	1
Engine Wiring Harness Kit	77072458AC	Yes	1
Charcoal Canister Air Filter	04891564AC	Yes	1
Ground jumper	68060322AG	Yes	1
O2 Sensor	05149180AA	Yes	3
O2 Sensor, Left Upstream	05149171AB	Yes	1
Powertrain Control Module	68414710AA	Yes	1
CAN Bus Interface Device	77072456AB	Yes	1
Charge Air Temp. Sensor	05149279AC	Yes	1
Intake Air Filter	77070038	Yes	1
Nut M10x1.50	06104717AA	Yes	4
Stud M10x1.50x77	06507880AA	Yes	4
Purge Valve Intake Hose	68206046AD	Yes	1
2016 Oil Pressure Sensor	05149062AB	Yes	1

Note: Revision level (suffix) of part numbers are subject to change.

Engine sold separately:

6.4L HEMI® engine part number: 68303090AA

This kit and instruction sheet is designed for 2013-2021 model year engines, part numbers listed above.

Not compatible with 6.4L engines from 2012 and older.

Not compatible with 6.4L engines from RAM truck.

Crankshaft target ring must be part number 04893290AA, a valley width of 6.306 mm measured at the outer diameter (OD). The crankshaft position sensor part number is 68140678AB.



Drivetrain Requirements

Axle Drive Ratio

The recommended axle drive ratio should be 2.61:1 to 3.90:1 to obtain optimal vehicle performance and fuel economy. A Limited Slip Differential (LSD) or Open differential is recommended for best drivability.

Tire Size

The recommended rear tire size is 28 to 29.5 inches in overall diameter.

Fuel

The fuel grade required for 6.4L HEMI is premium (91 octane or greater). The fuel pressure is a constant 58.5 PSI with the engine running. Fuel pump flow requirements: Minimum 222 Lbs/Hr @ 58.5 PSI (+/- 5 PSI). Recommended Fuel Pressure Regulator (FPR) is WIX 33737.

Additional Parts

Some additional parts may be needed that are not supplied in this kit to complete the powertrain. Each application is unique and all possibilities and configurations may not be covered in this instruction sheet. These parts can to be ordered separately through your local Chrysler Dealer or an aftermarket supplier.

Front End Accessory Drive (FEAD) Kit

The engine will come assembled with a car front engine cover. A FEAD kit is necessary to operate engine, the basic FEAD kit is part number 77072445.

Exhaust Manifolds

This crate engine does not come with exhaust manifolds. Any late model Hemi exhaust manifold/header will bolt up. What manifolds will fit your chassis will depend on your specific installation. We recommend tubular headers with 2" primary diameter for optimum performance. Log-style Exhaust manifold kit 77072462AB is also available from Mopar.

Engine Mounts

Engine mounts to be fabricated or purchased from an aftermarket source to fit the specific application. The engine side aluminum mounting brackets that are included on the engine are from a 2016 Dodge Challenger. It is recommended that the engine mounts incorporate production style engine dampers to allow for engine vibrations. Engine is installed at a 2° angle (rear down) on a 2016 Dodge Challenger.

Oil Pan

The oil pan supplied with the engine is a front sump oil pan design from a 2016 Dodge Challenger. Some applications may require a rear sump oil pan. The kit part number for a rear sump oil pan is 77072450AB.

Transmission

The flywheel and clutch or flex plate and torque converter combinations needed may be unique to the

application. A flywheel and clutch assembly from a 2016 Dodge Challenger will be included with all engines, please utilize the correct combination of parts for the desired drivetrain selected.

Starter

Ensure the correct starter is selected for your transmission and flex plate or flywheel combination. A starter nose spacer may be required for the starter motor to properly engage and spin the engine. The production starter for a Challenger 6.4L with a manual transmission is Part Number 68066177AB.

Important Safety & Emissions Information

⚠ WARNING

To prevent SERIOUS INJURY or DEATH:

- ALWAYS wear eye protection and appropriate protective clothing. You may be exposed to flammable, corrosive and hazardous liquids and materials when installing an engine.
- ALWAYS secure the vehicle with the parking brake or wheel chock before working on a vehicle.
- If you jack the vehicle, securely support the vehicle using jack stands before working under the vehicle.
- Make sure you or the installer has the appropriate skills and the tool required to safely install the engine.
- If you do not understand the instructions, call MOPAR for assistance at 1-888-528-HEMI (4364).
- NEVER modify wiring in the accelerator pedal system.
- Disconnect the battery before beginning work on the vehicle.
- DO NOT connect battery until all connections are made.

⚠ WARNING

DO NOT start or run an engine in a closed garage or in confined area. Exhaust gases contain Carbon Monoxide (CO), which is odorless and colorless. Carbon Monoxide is poisonous and can cause serious injury or death when inhaled.

Follow the precautions below to prevent Carbon Monoxide poisoning:

- DO NOT inhale exhaust gases.
- NEVER run the engine in a closed area, such as a garage, and never sit in a parked vehicle with the engine running for an extended period.



EMISSIONS STATEMENT

Intended Use:

392 HEMI EC ENGINES ARE DESIGNED FOR INSTALLATION IN

1. ANY MOTOR VEHICLE MANUFACTURED PRIOR TO MODEL YEAR 1996, AND



2. ANY MOTOR VEHICLE MANUFACTURED WITH A WEIGHT OF 2500 KG (4500 LBS), AND
3. IN ANY VEHICLE THAT LACKS FEATURES CUSTOMARILY ASSOCIATED WITH SAFE AND PRACTICAL HIGHWAY USE THAT IS OPERATED NOT ON A STREET OR HIGHWAY.

IT MAY BE A VIOLATION OF FEDERAL LAW SUBJECT TO CIVIL PENALTY TO INSTALL A 392 EC HEMI ENGINE IN ANY MOTOR VEHICLE DESIGNED FOR TRANSPORT ON A STREET OR HIGHWAY THAT WAS MANUFACTURED IN MODEL YEAR 1996 AND LATER.

Operation and Use Limitations:

- Federal and California law prohibit tampering with emissions control equipment or components required to be equipped on Motor Vehicles. This means that persons may not remove or render inoperative any device or element of design that impairs the emissions of such Motor Vehicles. Violators of this prohibition may be subject to civil penalty.
- HEMI engine kits may not be used in place of a regulated or certified nonroad engine (such as in marine applications).
- Installation of a HEMI engine in violation of these Instructions will void any applicable MOPAR warranty.
- 6.4L engines from 2013-2017 Challenger/Charger/300 may be comparable to a HEMI Engine when installed in appropriate vehicles as referenced above along with the appropriate HEMI Engine Kit.

Mopar Performance customers are responsible for complying with applicable federal state and local environmental laws and regulations. Many Mopar Performance parts and components are designed to be equipped in vehicles that are operated not on streets or highways (such as vehicles intended for competition or off-road use). Motor Vehicles designed for transport on streets or highways and equipped with such parts may cause such Motor Vehicles to be out of compliance with applicable emissions standards. It may be a violation of federal and state law to operate such Motor Vehicles equipped with such parts, except where vehicles equipped with such parts are operated not on streets or highways and where such vehicles lack features customarily associated with safe and practical highway use.

If you install such parts on a Motor Vehicle, and your Motor Vehicle fails a required state or local inspection and maintenance (I/M) emissions test, including any test required to maintain or renew your Motor Vehicle's registration, or if your Motor Vehicle is subject to an emissions recall, in either case FCA US LLC may not be required to repair your Motor Vehicle under the emissions warranty, and you may be required to remove those parts and replace them with other parts at your own expense in order to



obtain repairs necessary to pass the I/M emissions test or to ensure your Motor Vehicle is compliant with applicable emissions standards after the recall repair.

Those parts marked in this catalogue with a superscript 1 before the part number and appropriately marked on their packaging may legally be used on a vehicle that is not operated on streets or highways and that lacks features customarily associated with safe and practical highway use.

Limited Warranty:

Federal law requires emissions parts on new Motor Vehicles and engines to be warranted for at least two years or 24,000 miles, whichever comes first.

California Air Resources Board Executive Label

Note: The Vehicle Emission Control Information (VECI) label(s) must be in place for the life of the vehicle. Please place the CARB E.O. Label Supplied in the Kit in a location easily visible within the engine bay of the vehicle, if the vehicle has a VECI label, please affix label adjacent to original. **This product information label is required to aid in passing the California Smog Check program.**

The label contains the Executive Order Number for the 392 EC HEMI Engine Kit.

CARB Readiness Status

⚠ WARNING

To prevent SERIOUS INJURY or DEATH:

- The driving portions of the CBID calibration and CARB Readiness testing involve driving at speeds ranging from 20 mph to 70 mph with closed throttle deceleration from above 60 mph to 40 mph and constant speed above 20 mph for greater than 10 miles.
- The driving portions of the CBID calibration and CARB Readiness testing are to be completed on roads where legal speeds allow and traffic is light.
- The procedures require careful following of instructions provided and a passenger is recommended to assist by calling out instructions allowing the driver to remain focused on the road conditions.
- When performing any vehicle calibration or driving test, always be aware of road conditions and traffic at all times. If road conditions require you to deviate from the instructions given, you may restart the procedures when road conditions improve.
- If you do not understand the instructions, call MOPAR for assistance at 1-888-528-HEMI (4364).

Prior to performing any CARB Readiness Status procedures, read and perform the CAN Bus Interface Device (CBID) calibration using the CBID's instruction sheet. The majority of the monitors should be completed under normal driving conditions without the need to follow these procedures.

The following procedure has been established to assist with enabling and running OBD II monitors. The order listed in the following procedure is intended to allow the customer to effectively complete each monitor and to set the California Air Resources Board (CARB) Readiness Status in the least time possible.

NOTE: Once the monitor run process has started, do not turn OFF the ignition. By turning the ignition key OFF, monitor enabling conditions will be lost. By performing a battery disconnect, or selecting



erase DTCs, the CARB Readiness and all additional OBD II information will be cleared. Once the monitor is complete and it is safe to do so, turn OFF the ignition and back ON to see pass information.

Monitor Preliminary Checks:

1. Plug a scan tool into the vehicle's Data Link Connector (DLC).
 2. Turn the ignition, KEY ON - ENGINE OFF. Watch for the MIL lamp to illuminate during the bulb check. The MIL lamp must have illuminated.
 3. Using a scan tool check for Powertrain related DTCs.
- Verify that no emissions-related DTCs are present. If an emissions-related DTC is present, the OBD II monitors may not run and the CARB Readiness will not update.
 - The emissions-related DTC needs to be repaired and then cleared. By clearing DTCs, the OBD monitors must be run and completed to set the CARB Readiness Status.

Using a scan tool check the CARB Readiness Status.

Do all of the CARB Readiness Status Locations read YES?

- YES - all monitors have been completed and this vehicle is ready to be I/M (Inspection and Maintenance) or emission tested.
- NO - then the following procedure needs to be followed to run/complete all available monitors.

NOTE: Only complete the monitors, which are not YES in the CARB Readiness Status. Specific criteria need to be met for each monitor. The most efficient order to run the monitors has been outlined below, including suggestions to aid the process.

O2 Sensor Heater Monitor

This monitor will run once the heaters are energized. Pass information is processed at power down.

Catalyst / O2 Monitor

The catalyst and O2 monitor information are acquired and processed at the same time. Most vehicles need to be driven at a constant engine and vehicle speed for 30 seconds.

- Engine temperature greater than 70°C (158°F)
- Engine run time greater than 92 seconds prior to 30 second steady state driving conditions
- Vehicle speed between 26 to 70 mph (42 to 112 km/h)
- Engine RPM between 1200 to 2500 RPM

Misfire Monitor

The misfire monitor is a continuous two-trip monitor. The monitor uses two different tests/counters:

- 200 revolution counter - Looks for misfire that can cause immediate catalyst damage.
- 1000 revolution counter - Looks for misfire that can cause emissions to increase 1.5 times the Federal Test Procedure (FTP) standards. This test also identifies misfire percentages that might cause a durability demonstration vehicle to fail an Inspection and Maintenance Program tailpipe emissions test.



NOTE: The adaptive numerator must be learned before the PCM will run the Misfire Monitor. The PCM updates the Adaptive Numerator at every key-ON, and is relearned after battery disconnect. The Misfire Monitor will not run until the Adaptive Numerator has updated since the last battery disconnect. If the Adaptive Numerator is equal to the default value, then the PCM knows the Adaptive Numerator has not been learned and does not permit the Misfire Monitor to run. If the Adaptive Numerator exceeds a calibrated percentage, the PCM sets a DTC for CKP NOT LEARNED and illuminates the MIL.

Component Instructions & Guidelines

Accelerator Pedal

Follow accelerator pedal installation recommended guidelines below. Torque to 7 N·m (5 Ft. Lbs.). Please refer to the Break-In/Maintenance section for the required pedal learn function.

Label	Description	Minimum Clearance	Maximum Clearance
A	Clutch to Brake	60mm	-
B	Brake to Accelerator	65mm	80mm
C	Accelerator to Transmission Tunnel	35mm	-
D	Accelerator to Brake - Depth	43mm	47mm

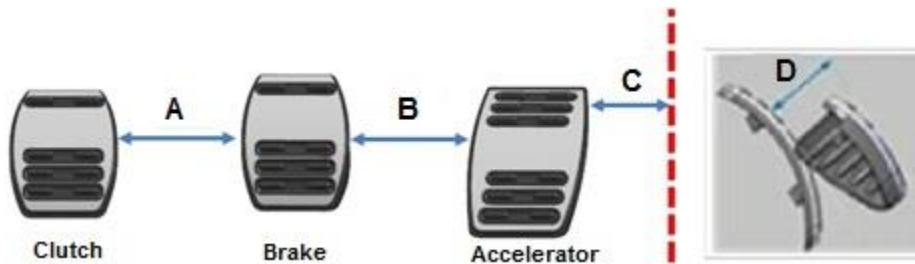

Powertrain Control Module (PCM)

Fasten PCM using the 3 fastener locations on the edges of the PCM. Do not over tighten fasteners as damage may occur on PCM housing. This PCM will not function in a current production vehicle. Connect a ground cable to PCM housing.

NOTICE

The PCM and the engine harness PCM connectors are environmentally sealed. This unit can be mounted anywhere in the vehicle, however it is not recommended to be installed near hot locations such as the exhaust system, on the engine, or high splash areas such as the wheel wells. If routing the wiring harness through the bulkhead or any sheet metal, a grommet is required to prevent damage.

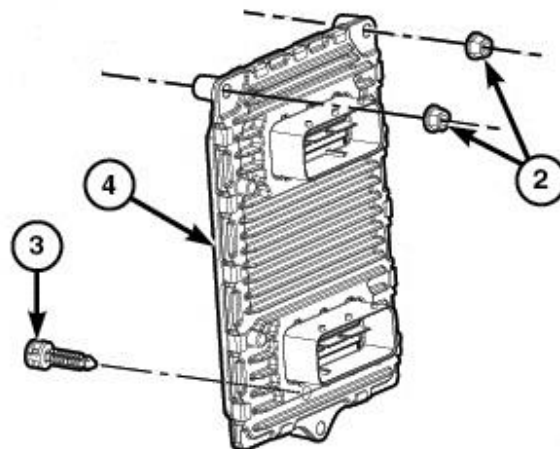

Coolant Lines & Radiator Fans

Ensure that the correct fan is chosen for the application. This system has a 30 Amp maximum fused output for a fan. Mount appropriately sized fans to appropriately sized radiator for the application used. The fan is programmed to turn on at 107°C (225°F). Use radiator coolant hoses 45 mm (1.75 inches) and fit to specific application. An additional fitting may be on the water pump, if not in use remove fitting and install an appropriate plug.

NOTICE

When installing coolant lines ensure there are no sharp bends that may restrict coolant flow. Use tightly secured clamps on hoses and inspect for leaks. Adequate engine cooling is necessary to prevent damage to engine. No air bubbles should be trapped within coolant lines, bleed system correctly. Do not run engine above 116° Celsius or 240° Fahrenheit. Normal temperature range is 93–110°C (200–230°F).

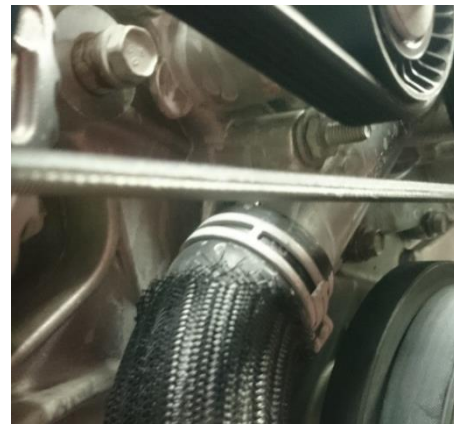

Rear Heater Lines

If bypassing heater core, recirculate coolant lines at the back of the engine by connecting one side of coolant line to the other using an appropriate length of hose to ensure no sharp bends are present and fasten with hose clamps. Use 5/8 inch inner diameter (ID) hose. If using a heater core, coolant line flow direction is as pictured.

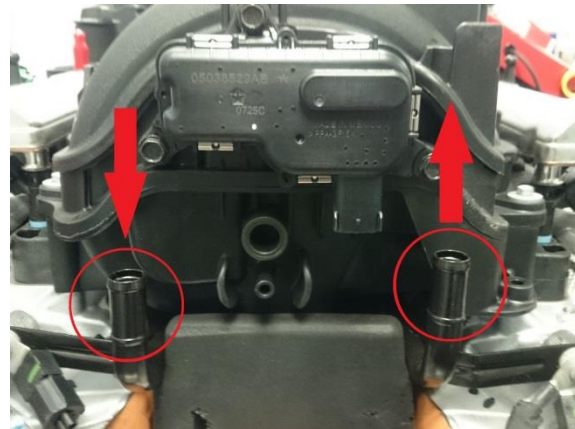

Front End Accessory Drive (FEAD) Systems

Install selected FEAD kit and FEAD Add-On kits as per their included instruction sheet.

Proper tension must be applied to the serpentine belt. Tensioner must not be against either bump stop and must be applying tension to belt. Use appropriate length belt included within kit or suggested in instruction sheet.

Intake Filter

Intake filter provided is part number 77070038. Install this part by fabricating an intake tube to fit your vehicle's space constraints. The intake filter must be within 600 mm (23.6 inches) of the throttle body. Create a bracket to hold intake filter tube and fasten to engine block using an empty fastener location. Fasten intake tube to the throttle body using 89 mm (3.5 inches) silicone couplers with appropriately sized hose clamps. Ensure filter is fastened correctly and no leaks are present. Install the Air Inlet Temperature (AIT) sensor to tube within 152 mm (6 inches) of the throttle body. Use a 1/2 inch ID rubber grommet when installing AIT sensor into a metal intake tube.

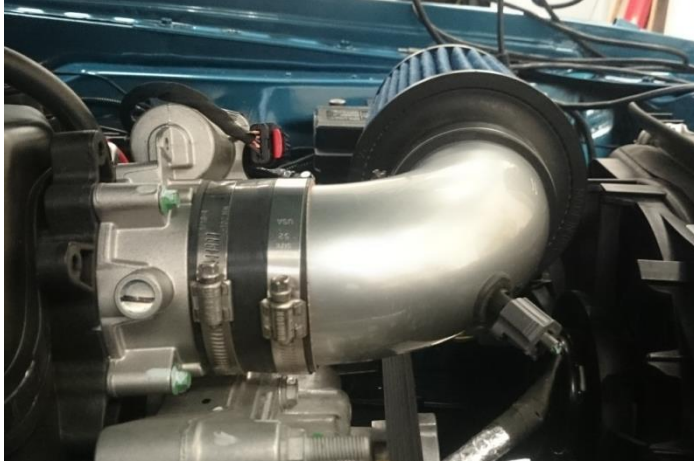

Make-Up Air

Use 3/4 inch ID size hose to connect the make-up air tube (located next to the oil filler neck) to the intake system prior to throttle body. Install a fitting to intake air tube and route make-up air tube to fitting using appropriate fittings and clamps.

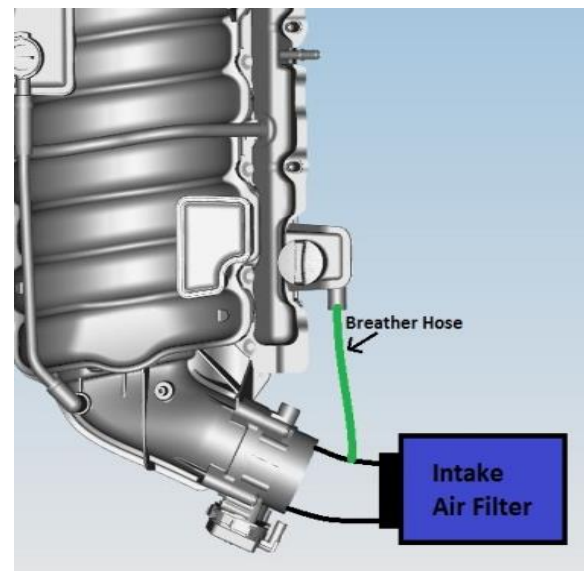

Fuel Lines

Fuel injectors and fuel rail will come pre-installed on engine. The fuel rail is a non-return style fuel rail. Use only fuel grade hoses and fittings when installing fuel system. Fuel rail inlet size is 3/8 inch SAE quick release. Fuel pump must deliver a minimum of 222 Lbs/Hr at 58.5 psi. A Fuel Pressure Regulator (FPR) is needed for this non-return style fuel system, the FPR can be external or internal to the fuel pump. The FPR should be placed prior to fuel inlet on fuel rail. Follow diagram below for FPR layout.

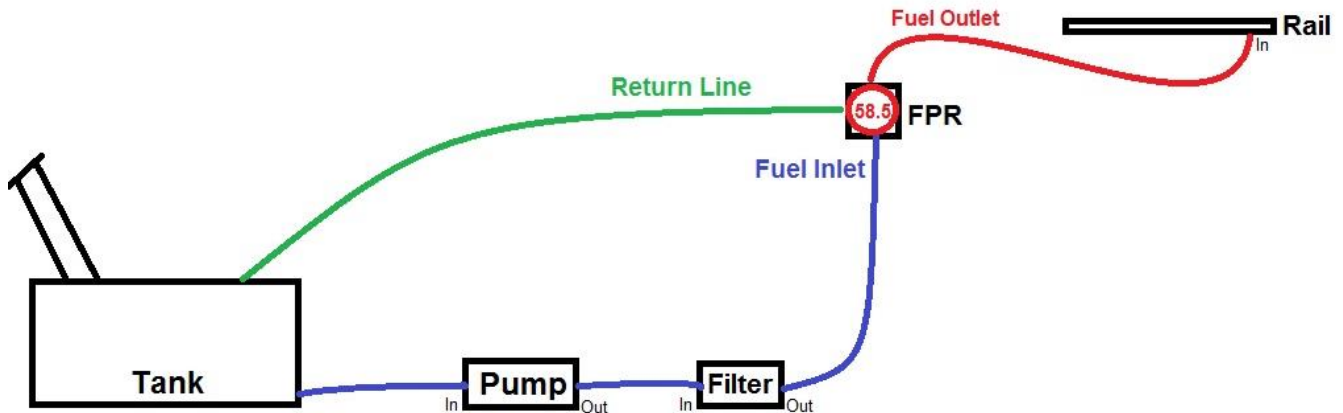

Vacuum

Vacuum reference can be taken at the fitting at the back of the intake manifold. This can be used as the brake booster vacuum line or any other vacuum reference needed. If not being used, cap this fitting with a 3/8 inch ID vacuum hose cap.



Oil Filter Adapter & Cooler (6.4L Only)

The oil cooler mounted to the engine may be removed and the oil filter can be used without this cooler attachment. To eliminate the cooler, a threaded oil filter connector part number 04892338AC, will need to be used to allow the oil filter to thread onto the engine block. To utilize the oil cooler, connect coolant lines to the two fittings; either fitting can be in or out flow.



Evaporative Emissions Control (EVAP) System Install

The EVAP purge Solenoid attaches to a bracket near the right rear of the engine.

1. 6.4L – Connect the purge valve intake hose to the EVAP purge solenoid. Connect hose to intake manifold near throttle body.
2. Connect the EVAP purge solenoid wire harness connector.
3. Mount Charcoal canister in vehicle near fuel tank using the two attached brackets.
4. Follow fuel vapor line routing pictured. Use only fuel grade lines (3/8 inch ID and 5/8 inch ID) with hose clamps to secure lines to charcoal canister.
5. Connect the charcoal canister air filter to the atmospheric vent line.
6. Check for leaks after the starting process is complete.

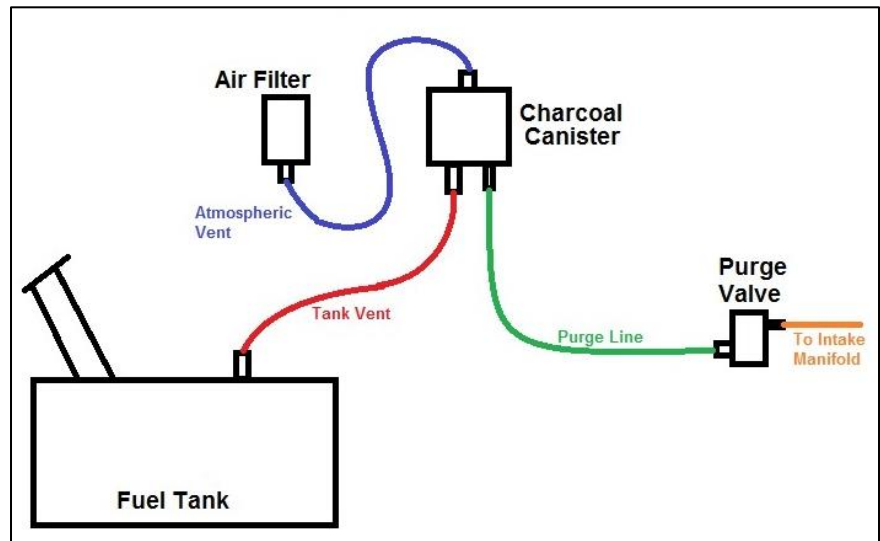
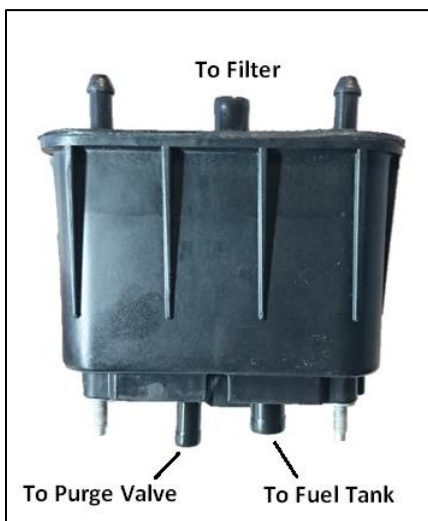
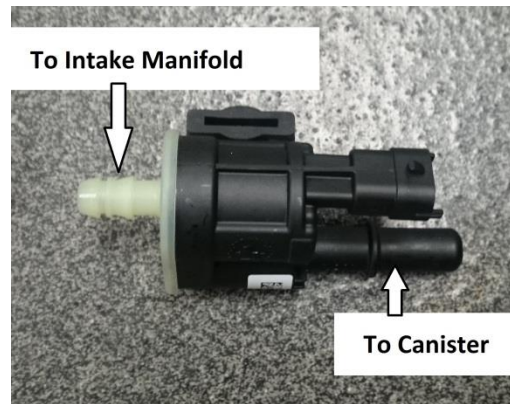
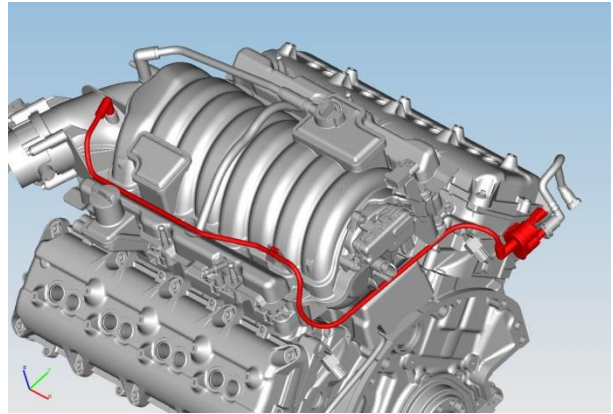

Catalytic Converters

⚠ WARNING

To prevent **SERIOUS INJURY**

- The normal operating temperature of the exhaust system is very high. Never work around or attempt to service any part of the exhaust system until it has cooled. Special care should be taken when working near the catalytic converter. The temperature of the converter rises to a high level after a short period of engine operating time.

1. Install the exhaust manifold studs into the manifold flange
2. Position the catalytic converter onto the exhaust manifold flange and install the flange nuts (1) finger tight.
3. Tighten the exhaust manifold flange nuts to the proper 31 N·m (23 Ft. Lbs)
4. Cut, rotate at flange and weld to fit specific application. The distance between the catalytic converter and the exhaust manifold flange must be between 38 mm to 140 mm (1.5 to 5.5 inches).
5. Check the exhaust system for contact with the body panels. A minimum of 25 mm (1.0 inches) is required between the exhaust system components and body/frame parts. Make the necessary adjustments if needed. Cut and modify exhaust after catalytic converter only.
6. Check to ensure you have at least 25 mm (1.0 inches) clearance to oil pan.
7. Check for leaks after the full exhaust is installed using leak finder fluid and air pressure from an air compressor.

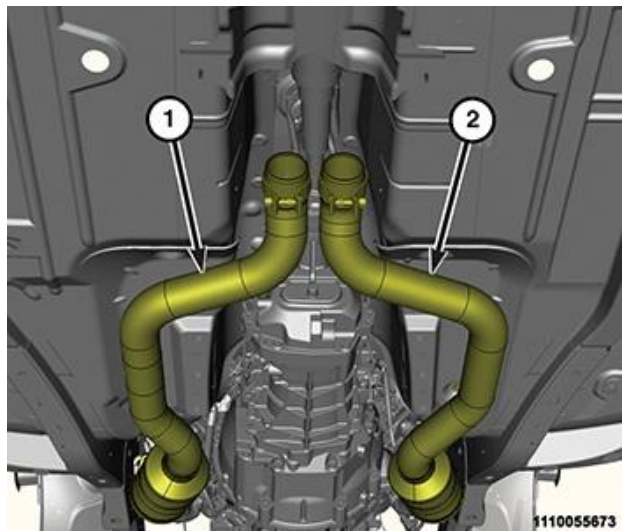
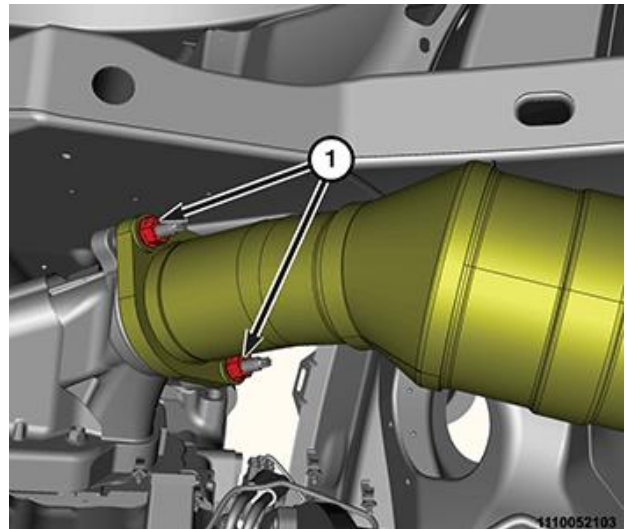

NOTICE

The air pressure must not exceed 27.6kPa (4 psi), otherwise engine damage can occur.

NOTE (6.4L ONLY): Ensure included gasket is in place. Replacement gasket part number: 68164708AA.

Engine Connections

⚠ WARNING

To prevent SERIOUS INJURY or DEATH:

- Make sure you or the installer has the appropriate skills and the tool required to safely install the engine.
- If you do not understand the instructions, call MOPAR for assistance at 1-888-528-HEMI (4364).

Engine Harness

Each engine wiring kit will have a different number of connectors. Ensure all connectors are connected in their appropriate location and are in the locked position. The diagrams below show all the engine and chassis connectors. Follow wiring instructions carefully.

NOTICE

- Ensure the wiring harness is secured every 100 mm (4 inches) and routed to avoid potential damage to the wiring. Make sure any unused wiring is properly secured and protected.
- Some cavities may be populated with wires however, those wires are not used in this configuration. See pinouts for circuits used.
- All connector diagrams are in wire insertion view.
- To diagnose a wiring issue outside of this manual, use 2016 Dodge Challenger service information.
- All grounds must be clean and secure. No paint can be present between the ground and body contact point. There are multiple grounding points on the engine and chassis side harnesses, as well as an engine grounding cable part number 68060322AG. This part is to be fastened on one end to the engine block and the other end to the vehicle's chassis, there should not be tension in the Ground Jumper.
- Soldering connections and wire splicing instruction can be viewed on the final page of the wiring section.

Code	Color	Code	Color	Code	Color	Code	Color	Code	Color
BK	Black	DB	Dark Blue	LB	Light Blue	PK	Pink	VT	Violet
BU	Blue	DG	Dark Green	LG	Light Green	RD	Red	WT	White
BR	Brown	GY	Gray	OG	Orange	TN	Tan	YL	Yellow

Capacitors

As part of the ignition system there are 2 capacitors on the back of the engine, one on each side bolted to the cylinder head. Plug in the connectors for both capacitors. The capacitors have a 2 pin connector.

Pin	Function	Color	GA
1	FUSED ASD RELAY OUPUT	BR/YL	16
2	N0 - No Connect	NA	



Ignition & Fuel

There are 8 coil plug connectors and 8 fuel injector connectors, 4 on each side. Ensure that the correct plug is connected for each cylinder to avoid misfires. Firing order is 1-8-4-3-6-5-7-2.

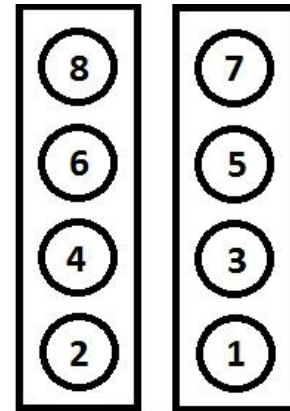

Front
Engine Harness Layout
for Ignition and Fuel Injection

Coil Plug Connectors (3 pin)

Pin	Function	Color	GA
Coilpack 1			
1	COIL CONTROL 1	DB/DG	16
2	FUSED ASD RELAY OUTPUT	BR/YL	16
3	NO CONNECT	NA	
Coilpack 2			
1	COIL CONTROL 2	DB/TN	16
2	FUSED ASD RELAY OUTPUT	BR/YL	16
3	NO CONNECT	NA	
Coilpack 3			
1	COIL CONTROL 3	DB/OG	16
2	FUSED ASD RELAY OUTPUT	BR/YL	16
3	NO CONNECT	NA	
Coilpack 4			
1	COIL CONTROL 4	DB/GY	16
2	FUSED ASD RELAY OUTPUT	BR/YL	16
3	NO CONNECT	NA	
Coilpack 5			
1	COIL CONTROL 5	DB/YL	16
2	FUSED ASD RELAY OUTPUT	BR/YL	16
3	NO CONNECT	NA	
Coilpack 6			
1	COIL CONTROL 6	DB/OG	16
2	FUSED ASD RELAY OUTPUT	BR/YL	16
3	NO CONNECT	NA	
Coilpack 7			
1	COIL CONTROL 7	BR	16
2	FUSED ASD RELAY OUTPUT	BR/YL	16
3	NO CONNECT	NA	
Coilpack 8			
1	COIL CONTROL 8	DB/YL	16
2	FUSED ASD RELAY OUTPUT	BR/YL	16
3	NO CONNECT	NA	

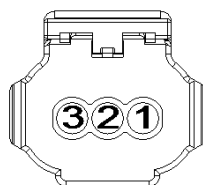

Fuel Injector Connectors (2 pin)

Pin	Function	Color	GA
Fuel Injector 1			
1	INJECTOR CONTROL 1	BR/YE	20
2	ASD CONTROL OUTPUT	BR/WT	16
Fuel Injector 2			
1	INJECTOR CONTROL 2	BR/DB	20
2	ASD CONTROL OUTPUT	BR/WT	16
Fuel Injector 3			
1	INJECTOR CONTROL 3	BR/BU	20
2	ASD CONTROL OUTPUT	BR/WT	16
Fuel Injector 4			
1	INJECTOR CONTROL 4	BR/BG	20
2	ASD CONTROL OUTPUT	BR/WT	16
Fuel Injector 5			
1	INJECTOR CONTROL 5	BR/OG	20
2	ASD CONTROL OUTPUT	BR/WT	16
Fuel Injector 6			
1	INJECTOR CONTROL 6	BR/VT	20
2	ASD CONTROL OUTPUT	BR/WT	16
Fuel Injector 7			
1	INJECTOR CONTROL 7	BR/YL	20
2	ASD CONTROL OUTPUT	BR/WT	16
Fuel Injector 8			
1	INJECTOR CONTROL 8	BR/BU	20
2	ASD CONTROL OUTPUT	BR/WT	16

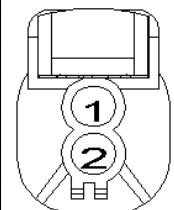

Starter Motor

There are 2 connections to be made for the starter, the starter battery connector and the starter solenoid connector. These wires will need to be extended if the starter will be placed on the driver side of the vehicle. The starter battery connector eyelet may not be compatible with all starter options. The eyelet may be replaced with an alternative eyelet.

Pin	Function	Color	GA
1	STARTER RELAY OUTPUT	YL/GY	14

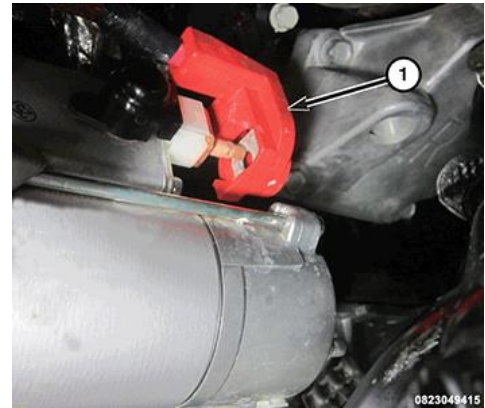

Alternator

The alternator has 2 connectors, the alternator connector and the alternator battery connector. Once the eyelet for the alternator battery connector is properly fastened in place, ensure that the cover is securely in place to avoid accidental connections to this terminal.

Pin	Function	Color	GA
1	GEN FIELD CONTROL	BR/GY	18
2	GEN SENSE	RD/VT	18



Engine Sensors

The knock sensors are bolted onto both sides of the engine block. They are located underneath the exhaust manifolds. Plug in the 2 pin connector to each knock sensor.

Pin	Function	Color	GA
Knock 1			
1	KS 1 SIGNAL	DB/YL	20
2	KS 1 RETURN	BR/LG	20
Knock 2			
1	KS 2 SIGNAL	BR/WT	20
2	KS 2 RETURN	WT/BR	20

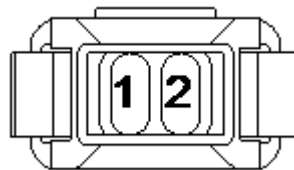

Charge Air Temperature Sensor is to be plugged in at the air intake, ensure that there is little to no tension on this sensor pigtail as this may damage sensor and sensor plug. A hole may be drilled into the pipe up to 152 mm (6 inches) away from the throttle body for installation.

Pin	Function	Color	GA
1	INTAKE AIR TEMP SIGNAL	DB/LG	20
2	SENSOR GROUND	BR/WT	20

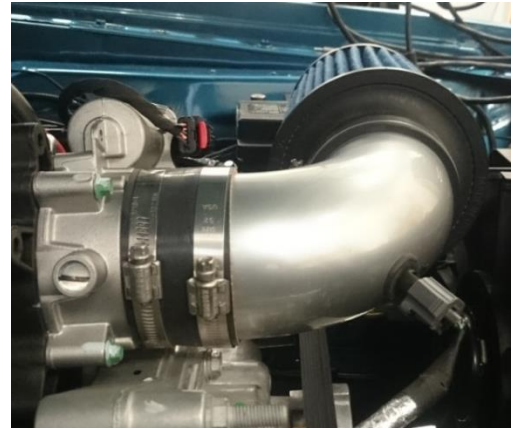
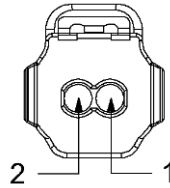

Manifold Absolute Pressure (MAP) Sensor is located on the back of the intake manifold. The MAP sensor has a 3 pin connector.

Pin	Function	Color	GA
1	MAP SIGNAL	VT/BR	20
2	SENSOR GROUND	DB/DG	20
3	5 VOLT SUPPLY	YL/PK	20

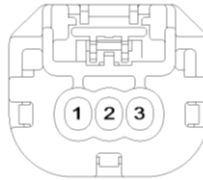

Crank Position Sensor is located on the passenger side of the engine near the bell housing flange. It is installed onto the engine block and has a 3 pin brown connector.

Pin	Function	Color	GA
1	5 VOLT SUPPLY	PK/YL	20
2	CKP GROUND	DB/GY	20
3	CKP SIGNAL	BR/LB	20

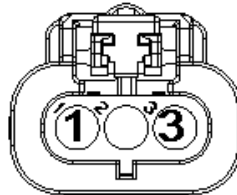

Cam Position Sensor, labeled “CMP” is a 3 pin connector that is located beside the upper radiator hose neck.

Pin	Function	Color	GA
1	5 VOLT SUPPLY	YL/PK	20
2	SENSOR GROUND	DB/DG	20
3	CMP SIGNAL	DB/GY	20

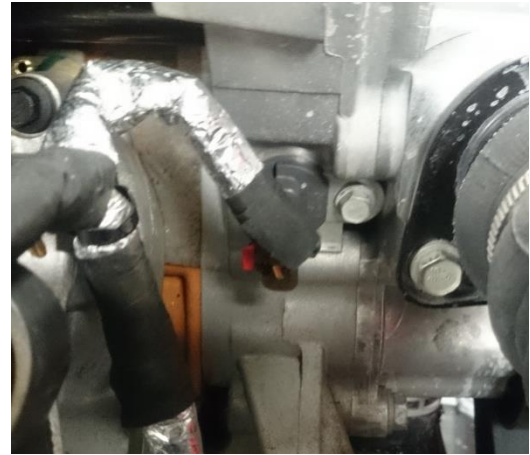
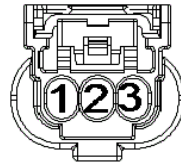

Oil Temperature and Pressure Sensor are connected near the oil filter location. The oil temperature sensor is facing the passenger side of the block and is directly above the filter location. The oil pressure sensor is located higher and to the right of the oil temperature sensor, it is plugged in facing the front of the engine. Replace the oil pressure sensor on 2017+ model year engines with the 2016 oil pressure sensor provided, torque to 15 N·m (11 Ft. Lbs).

Oil Pressure			
Pin	Function	Color	GA
1	5 VOLT SUPPLY	PK/YL	20
2	OIL PRESSURE SIGNAL	VT/GY	20
3	SENSOR GROUND	DB/DG	20
Oil Temp			
Pin	Function	Color	GA
1	SENSOR GROUND	BR/WT	20
2	ENGINE OIL TEMP SIGNAL	VT/BR	20

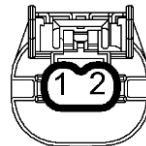
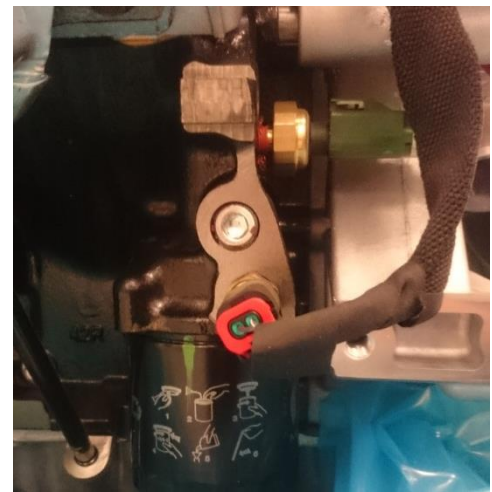
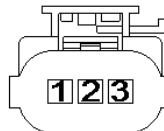

Coolant Temperature Sensor has a 2 pin connector on the front of the block above the water pump pulley.

Pin	Function	Color	GA
1	ECT SIGNAL	VT/OG	20
2	SENSOR GROUND	BR/WT	20

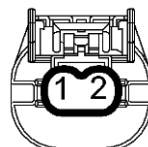

Throttle Position is a 6 pin connector that is on the throttle body assembly. Do not modify any wiring in this connector.

Pin	Function	Color	GA
1	ETC MOTOR (+)	TN/YL	18
2	ETC MOTOR (-)	TN/OG	18
3	TP 2 SIGNAL	BR/DG	20
4	5 VOLT SUPPLY	PK/YL	20
5	TP 1 SIGNAL	BR/OG	20
6	TP SENSOR RETURN	BR/DB	20

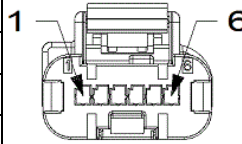

Variable Cam Timing (VCT)

VCT solenoid is located under the intake manifold. This will remain connected on the engine, connect the VCT Inline 6 pin connector.

VCT Inline			
Pin	Function	Color	GA
1	VCT CONTROL	DB	20
2	GROUND	BK	20
VCT			
Pin	Function	Color	GA
1	GROUND	BK	20
2	VCT CONTROL	DB	20

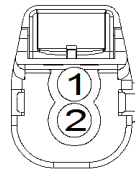
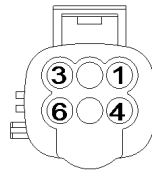

Short Runner Valve (SRV) (6.4L versions only)

The short runner valve is located on the back of the intake manifold above the vacuum reference fitting. The 4 pin connector for the short runner valve faces down.

Pin	Function	Color	GA
1	FUSED ASD RELAY OUTPUT	BR/YL	16
2	GROUND	BK	16
3	SRV ACTUATOR CONTROL SIGNAL	DB/LG	18
4	SRV SENSE OUPUT	DB/YL	18

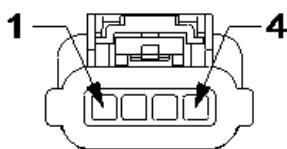

O2 Sensors

The threads of the new oxygen sensors are factory coated with anti-seize compound to aid in removal. Do not add any additional anti-seize compound to threads of a new oxygen sensor. Install the oxygen sensor (1) into the exhaust manifold and tighten to the proper to 52 N·m (38 Ft. Lbs.). Connect the oxygen sensor wire harness connector (2) and secure the wire harness to an appropriate location (3).

Upstream (Left & Right)

Pin	Function	Color	GA
O2 Driver Front			
1	O2 1/1 HEATER CONTROL	BR/LG	16
2	GROUND	BK	16
3	O2 RETURN UPSTREAM	BR/DG	20
4	O2 1/1 SIGNAL	DB/LB	20
O2 Passenger Front			
1	O2 2/1 HEATER CONTROL	BR/VT	16
2	GROUND	BK	16
3	O2 RETURN UPSTREAM	BR/DG	20
4	O2 2/1 SIGNAL	DB/LG	20

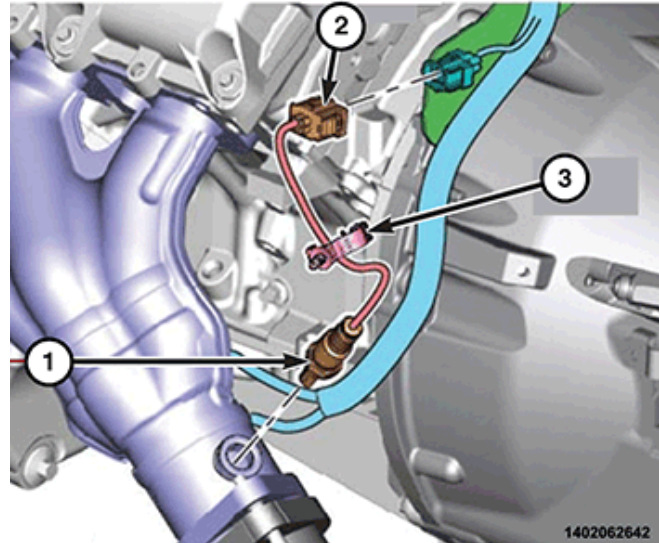

Downstream (Left & Right)

Pin	Function	Color	GA
O2 Driver Rear			
1	O2 1/2 HEATER CONTROL	BR/WT	16
2	GROUND	BK	16
3	O2 RETURN DOWNSTREAM	DB/DG	20
4	O2 1/2 SIGNAL	DB/YL	20
O2 Passenger Rear			
1	O2 2/2 HEATER CONTROL	BR/GY	16
2	GROUND	BK	16
3	O2 RETURN DOWNSTREAM	DB/DG	20
4	O2 2/2 SIGNAL	BR	20

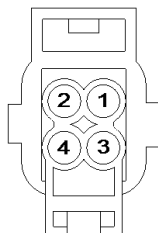
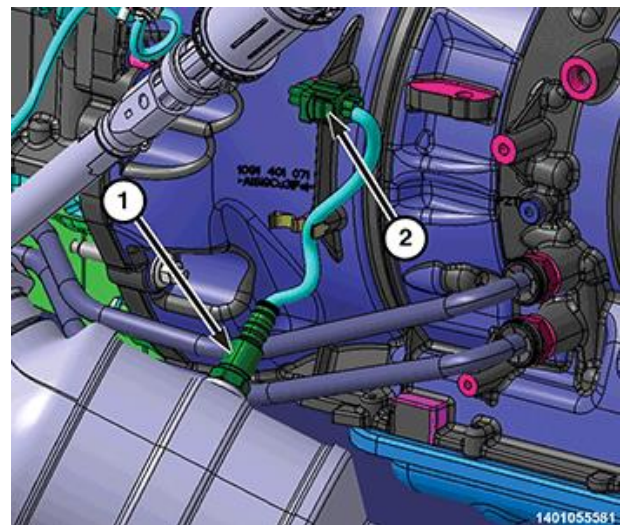

Body Harness

The body side harness consists of 2 sides, one side to route into the engine bay and mate with the PCM and PDC, and one side to the vehicle cabin for other connections. A grommet hole of 50 mm is needed in the bulkhead to route the harness. Ensure the hole that is cut is on a flat plane of a minimum material thickness to seal of 5 mm and is deburred. Feed the harness through the hole and insert the grommet in place.

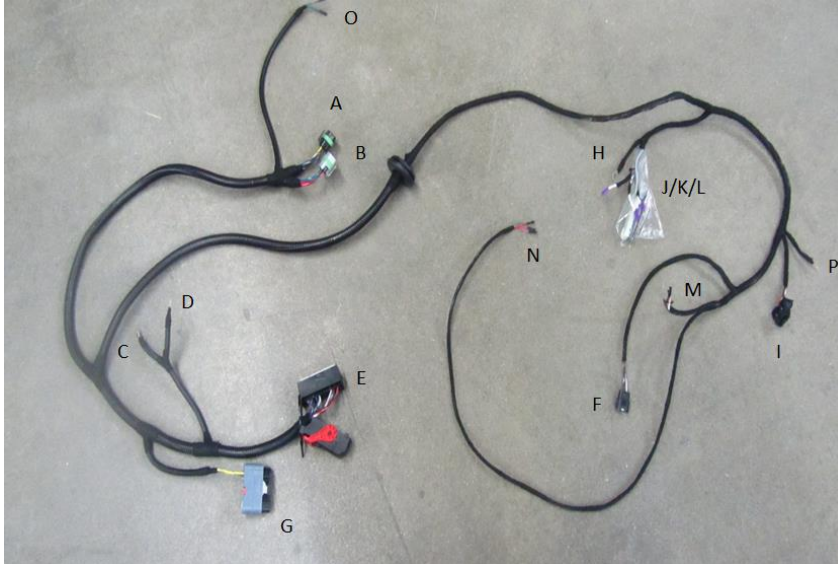

Call Out	Connector
A	PDC A - Black
B	PDC B - Gray
C	Ground
D	Ground
E	PCM - Body
F	Pedal
G	Inline - Body
H	Ground
I	DLC
J/K/L	Star Connectors
M/N/O	Blunt Leads
P	Ground

Dash / Blunt Leads

Each blunt end will require the correct corresponding connection on the vehicle.

N – Color: LB/TN – Gauge: 20 – Starter Relay Control: Connect to 12V source provided only when in crank position. Requires a 12V input from ignition switch to control the starter relay only when key is in the crank position.

N – Color: PK – Gauge: 20 – IGN Relay Control: Connect to 12V source provided when in crank and run position. Requires a 12V input from ignition switch to control the ignition relay when key is in the crank and run position.

N – Color: DG/OG – Gauge: 18 – Clutch Interlock: Connect to ground input from clutch pedal switch or neutral safety switch.

N – Color: RED – Gauge: 18 – Aux: Positive output for an auxiliary device. (12V output, 20A fuse)

O – Color: DB/OG – Gauge: 16 – Fuel Pump Feed: Positive output for an electric fuel pump. (12V output, 20A fuse)

O – Color: DG/RD – Gauge: 12 – Cooling Fan Feed: Positive output for an electric cooling fan. (12V output, 30A fuse)

Inline Engine and Body Harness

The inline engine and body harness connector is the only connection between the body harness and the engine harness. Some cavities may be populated with wires, however those wires are not used in this configuration.



Inline Engine			
Pin	Function	Color	GA
1	STARTER RELAY OUTPUT	YL / GY	14
2	FUSED ASD RELAY OUTPUT	BR / YL	16
13	ASD CONTROL OUTPUT	BR / WT	16
21	EVAP PURGE CONTROL	DB / WT	20

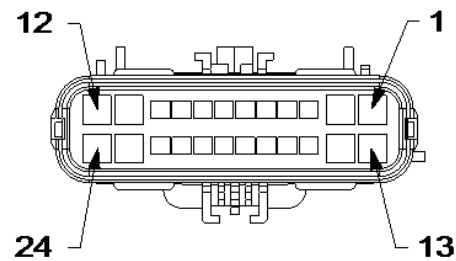

Inline Body			
Pin	Function	Color	GA
1	STARTER RELAY OUTPUT	YL / GY	14
2	FUSED ASD RELAY OUTPUT	BR	16
13	ASD CONTROL OUTPUT	BR / WT	16
21	EVAP PURGE CONTROL	DB / WT	20

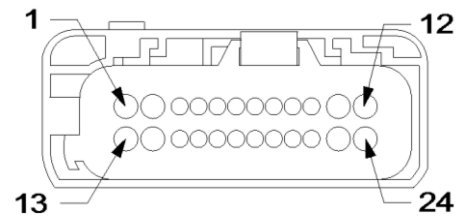

All diagrams are wire insertion view

CAN Bus Interface Device (CBID)

The CAN Bus Interface Device is part number 77072456AB. This part allows the PCM to receive vehicle speed input and to display a Malfunction Indicator Lamp (MIL). The CBID module contains an LED MIL on the component, additionally an external LED MIL can be connected. U1110 will be present at first start and remain on until CBID is installed and calibrated. Follow CAN Bus installation sheet.

Blunt Lead	Wire Color	Gauge	Function
M	PK/ BR	18	EXTERNAL MIL 12V POWER
M	WT/OG	20	CAN HIGH GATEWAY/STAR CONN
M	WT/VT	20	CAN LOW GATEWAY/STAR CONN
M	RED	18	GATEWAY BATTERY FEED
M	BK	18	GATEWAY GROUND

Power Distribution Center (PDC)

There are 2 connectors that plug into the PDC and 2 battery post terminals. Torque for the PDC feet is a maximum of 2.7 N·m (24 In. Lbs.).

NOTICE

The PDC connectors are environmentally sealed. This unit can be mounted anywhere in the vehicle, however it is not recommended to be installed near hot locations such as the exhaust system or high splash areas such as wheel wells.



Pin	Function	Color	GA
PDC 1			
1A	STARTER SOLENOID	YL/GY	14
1B	ASD RELAY CONTROL	BR/YL	20
1C	ASD RELAY FEED 1	BR	16
1D	ASD RELAY FEED 2	BR/WT	16
1E	CLUTCH INTERLOCK	DG/OG	20
1F	STARTER RELAY CONTROL	LB/TN	20
1G	FUEL PUMP REPLAY CONTROL	DB/TN	20
1H	FUEL PUMP FEED	DB/OG	12
PDC 2			
2A	DLC/ECM POWER FEED	RD	16
2B	GATEWAY POWER FEED	RD	18
2C	IGN SWITCH BATTERY FEED	RD	18
2D	ECM RUN/START FEED	PK/BR	18
2E	COOLING FAN FEED	DG/RD	12
2F	COOLING FAN RELAY CONTROL	DB/LG	20
2G	IGN/FUEL PUMP RELAY RETURN	BK/GR	18
2H	IGN RELAY CONTROL	PK	20

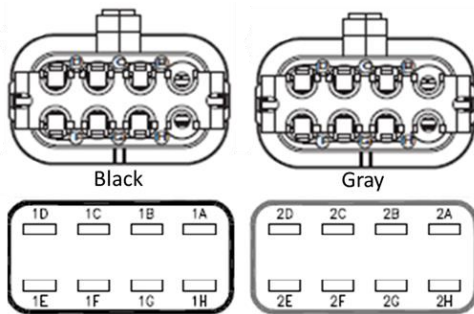
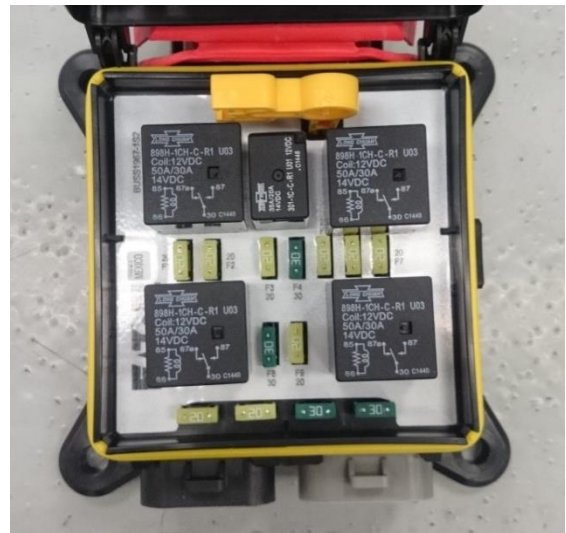

All diagrams are wire insertion view

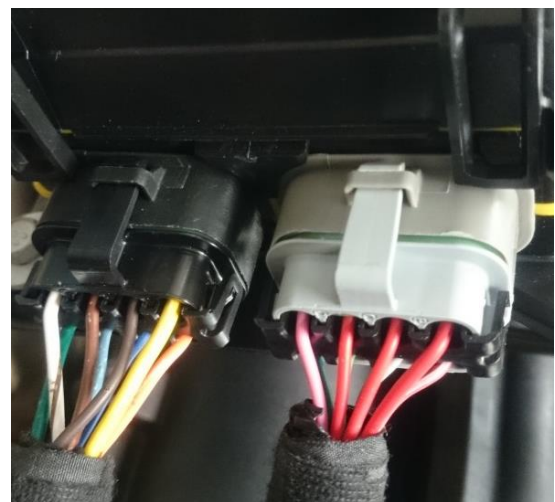

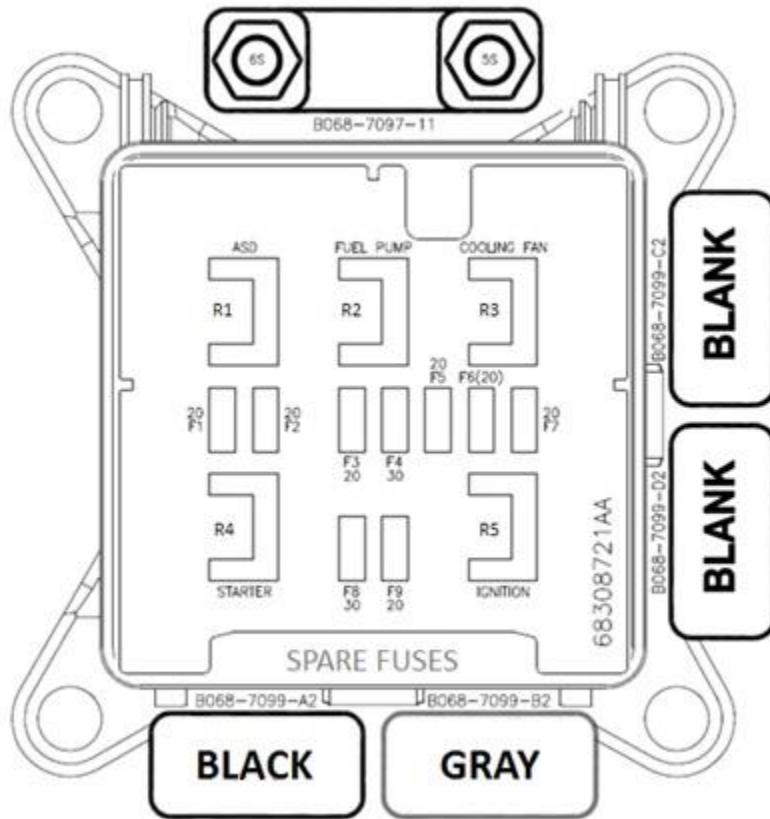

MINI FUSES	
F1	ASD 2 (20A)
F2	ASD 1 (20A)
F3	FUEL PUMP (20A)
F4	COOLING FAN (30A)
F5	AUX (20A)
F6	GATEWAY (20A)
F7	DLC/ECM (20A)
F8	STARTER SOLENOID (30A)
F9	IGNITION RUN/START (20A)
RELAYS	
R1	ASD
R2	FUEL PUMP
R3	COOLING FAN
R4	STARTER
R5	IGNITION

PDC Bus Bar & PDC Battery Connection

The PDC bus bar will already be installed on the PDC. The bus bar connects both PDC power studs together to allow for only one power cable to be connected. Connect the PDC Battery terminal to either power stud on the PDC above the bus bar. The power studs' maximum torque is 20.4 N·m (15 Ft. Lbs.), with a max power rating of 200A. Close the terminal flap when complete.



STAR Connector and Connections

The Star connector has multiple inputs; only 3 will be used in this application. Only two star connectors on the chassis harness will come installed to the star connector. Connect Star 3 when using the CAN Bus Interface Device.

Pin	Function	Color	GA
Star 1			
1	CAN +	WT/LG	20
2	CAN -	WT/LB	20
3	GROUND	BK/GY	20
Star 2			
1	CAN +	WT/YL	20
2	CAN -	WT/BK	20
Star 3			
1	CAN +	WT/OR	20
2	CAN -	WT/VT	20

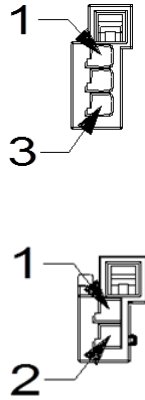

Pedal Connector

⚠ WARNING

To prevent SERIOUS INJURY or DEATH, NEVER modify wiring in the accelerator pedal system.

The accelerator pedal connector is a single 6 pin connector.

Pin	Function	Color	GA
1	APP 5 VOLT 1	BR/VT	20
2	APP SIGNAL 1	BR/WT	20
3	APP SENSOR GROUND 1	BR/YL	20
4	APP SENSOR GROUND 2	BR/VT	20
5	APP SIGNAL 2	WT/BR	20
6	APP 5 VOLT 2	VT/BR	20

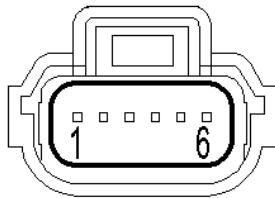

Data Link Connector (DLC)

This connector is an OBDII plug that can be mounted anywhere in the vehicle to diagnose issues and codes the PCM may be outputting. When reading codes, a P1400 code may be present. This indicates an aftermarket controller is being used. U1110 will be present at first start and remain on until CBID is installed and calibrated.

Pin	Function	Color	GA
4	GROUND	BK	20
5	GROUND	BK	20
6	CAN C (+)	GY/WT	22
14	CAN C (-)	YL	22
16	FUSED B (+)	RD	20

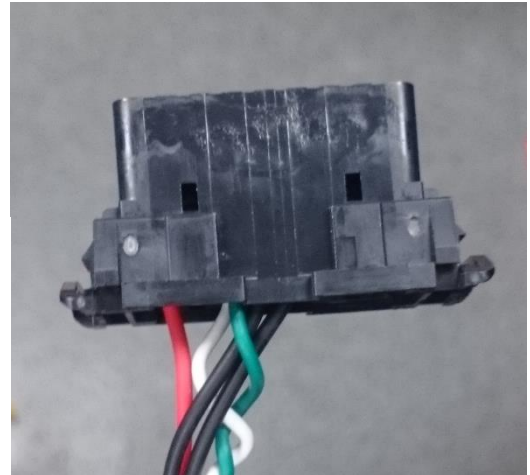
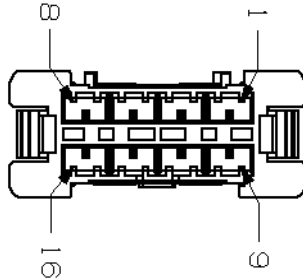

The wiring harness will include a DLC bracket. Install the bracket anywhere in the interior of the vehicle, allowing enough space to access the connector when needed. The connector will clip into the opening of the bracket.

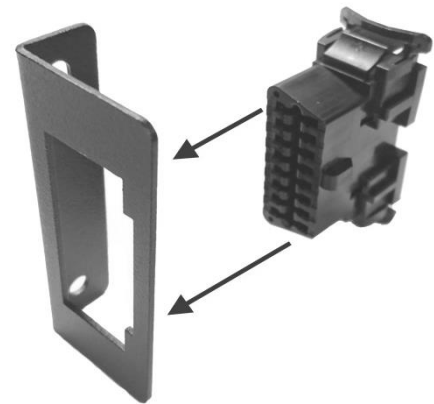

Evaporative Emissions Control (EVAP) System

Purge Valve

The Purge Valve is to be installed as per instruction located in the Emission System Install section. The purge valve has a 2 pin connector on the Engine Harness.

Pin	Function	Color	GA
1	EVAP PURGE CONTROL	DB/WT	20
2	GROUND	BK	20



Final Connection (Engine Harness)

WARNING

To prevent SERIOUS INJURY, DEATH or PROPERTY DAMAGE:

- DO NOT connect battery until all connections are made.

Battery

The battery must supply a minimum of 12.65 volts. Connect battery as final step before initiating starting procedures. Battery terminal should not be loose.



PCM Engine Harness			
Pin	Function	Color	GA
4	OIL PRESSURE SIGNAL	VT/GY	20
8	INJECTOR CONTROL 1	BR/YL	18
9	INJECTOR CONTROL 2	BR/DB	18
10	INJECTOR CONTROL 3	BR/LB	18
11	INJECTOR CONTROL 4	BR/TN	18
12	ECT SIGNAL	VT/OG	20
13	KS 2 SIGNAL	BR/WT	20
14	KS 1 SIGNAL	DB/YL	20
19	O2 1/2 SIGNAL	DB/YL	20
20	O2 RETURN DOWNSTREAM	DB/DG	20
21	O2 2/2 SIGNAL	BR	20
22	VCT CONTROL	DB	20
24	O2 1/1 HEATER CONTROL	BR/LG	16
32	GENERATOR FIELD CONTROL	BR/GY	18
33	ETC MOTOR (+)	TN/YL	8
34	ETC MOTOR (-)	TN/OG	18
35	GENERATOR SENSE	RD/VT	18
37	KS 2 RETURN	WT/BR	20
38	KS 1 RETURN	BR/LG	20
39	O2 1/1 SIGNAL	DB/LB	20
40	O2 RETURN UPSTREAM	BR/DG	20
41	O2 2/1 SIGNAL	DB/LG	20
43	EOT SIGNAL	VT/BR	20
44	IAT SIGNAL	DB/LG	20
45	MAP SIGNAL	VT/BR	20
48	O2 1/2 HEATER CONTROL SUPPLY	BR/WT	16
49	COIL CONTROL 3	DB/OG	16
50	COIL CONTROL 2	DB/TN	16
51	COIL CONTROL 1	DB/DG	16
53	SRV ACTUATOR CONTROL SIGNAL (6.4L ONLY)	DB/LG	18
60	SRV SENSE OUTPUT (6.4L ONLY)	DB/YL	18
65	TP SENSOR RETURN	BR/DB	20
66	SENSOR GROUND	DB/DG	20
67	5 VOLT SUPPLY	PK/YL	20
68	SENSOR GROUND	BR/WT	20
72	O2 2/1 HEATER CONTROL	BR/VT	16
73	COIL CONTROL 4	DB/GY	16
74	COIL CONTROL 5	DB/YL	16
75	COIL CONTROL 6	DB/OG	16
76	COIL CONTROL 7	BR	16
77	COIL CONTROL 8	DB/YL	16
79	INJECTOR CONTROL 5	BR/OG	18
80	INJECTOR CONTROL 6	BR/VT	18
81	INJECTOR CONTROL 7	BR/YL	18
82	INJECTOR CONTROL 8	BR/LB	18
85	CMP SIGNAL	DB/GY	20
86	CKP SIGNAL	BR/LB	20
87	5 VOLT SUPPLY	YL/PK	20
88	CKP GROUND	DB/GY	20
89	THROTTLE POSITION 1 SIGNAL	BR/OG	20
90	THROTTLE POSITION 2 SIGNAL	BR/DG	20
96	O2 2/2 HEATER CONTROL	BR/GY	16

PCM Body Harness			
Pin	Function	Color	GA
23	ECM RUN/START FEED	PK/BR	18
33	CAN LOW STAR CONN	WT/BK	20
41	GROUND	BK	20
52	ECM GROUND	BK	18
53	ECM GROUND	BK	18
57	CAN HIGH STAR CONN	WT/YL	20
67	PEDAL SENSOR GROUND 2	BR/RD	20
68	PEDAL SENSOR GROUND 1	BR/YL	20
69	PEDAL 5 VOLT 2	VT/BR	20
72	GROUND	BK	18
73	FUEL PUMP RELAY CONTROL	DB/TN	20
74	ASD RELAY FEED 2	BR/WT	16
75	ASD RELAY FEED 2	BR/WT	16
76	ASD RELAY FEED 2	BR/WT	16
78	COOLING FAN RELAY CONTROL	DB/LG	20
80	ASD RELAY CONTROL	BR/YL	20
87	ECM RUN/START FEED	PK/BR	20
91	PEDAL SIGNAL 2	WT/BR	20
92	PEDAL SIGNAL 1	BR/WT	20
93	PEDAL 5 VOLT 1	BR/VT	20
94	PURGE SOLENOID	DB/WT	20
96	DLC/ECM POWER FEED	RD	16

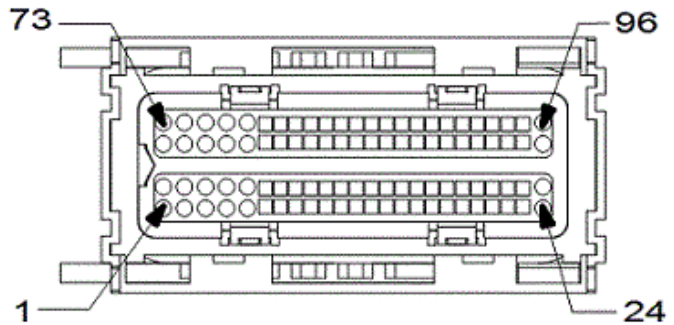

How to splice and connect blunt ends correctly:

1. Place the strands of the wires overlapping each other inside of the splice clip (1).

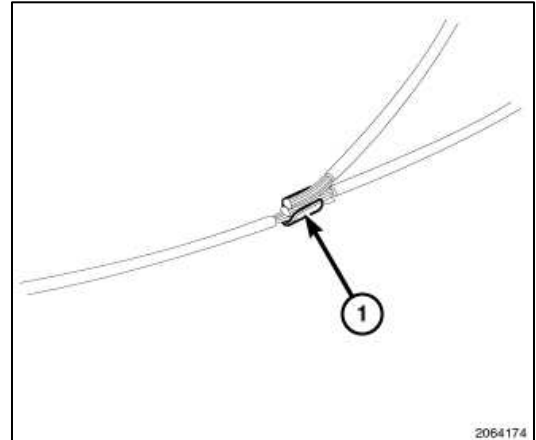

2. Using Mopar crimping tool (1) or equivalent, crimp the splice clip and wires together.

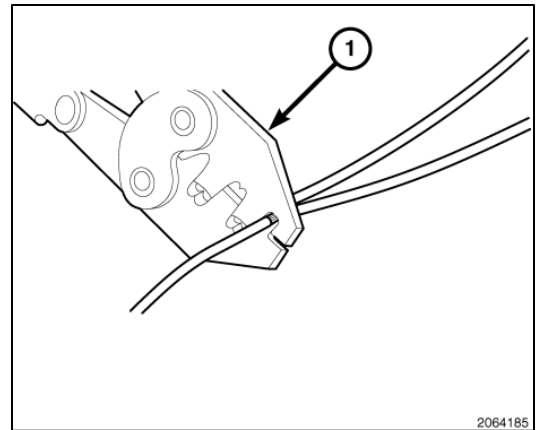

3. Solder (3) the connection (2) together using rosin core solder (1).

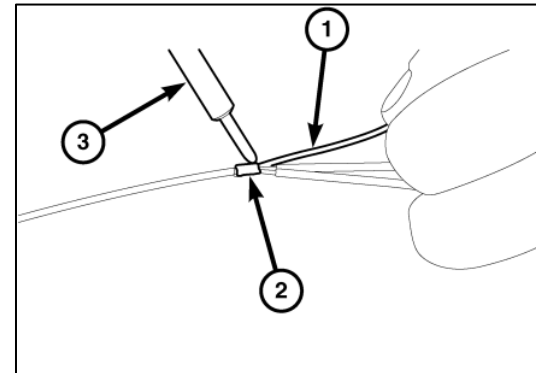

4. Center the heat shrink tubing (2) over the solder joint and heat using a heat gun. Heat the joint until the tubing is tightly sealed and sealant (1) comes out of both ends of the tubing.

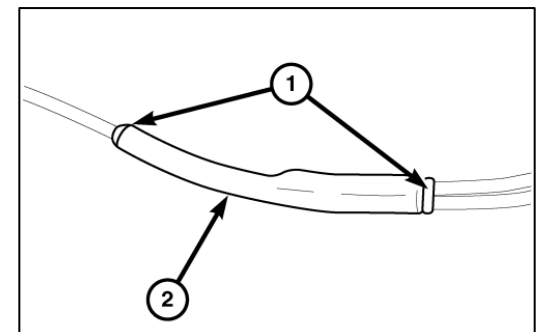



Break-In/Maintenance

Follow this procedure below in the correct order and read all content prior to starting your new engine.

Engine Oil

For best performance and maximum protection under all types of operating conditions, the manufacturer only recommends full synthetic engine oils that meet the American Petroleum Institute (API) categories of SN.

The engine oil filler cap also shows the recommended engine oil viscosity for the engine. Use synthetic engine oils provided the recommended oil quality requirements are met, and the recommended maintenance intervals for oil and filter changes are followed. Synthetic engine oils which do not have both the engine oil certification mark and the correct SAE viscosity grade number should not be used. The manufacturer strongly recommends against the addition of any additives (other than leak detection dyes) to the engine oil. Engine oil is an engineered product and its performance may be impaired by supplemental additives.

6.4L	SAE 0W-40, Synthetic API Certified	FCA Material Standard MS-12633	6.6 Liters	7 Quarts
------	------------------------------------	--------------------------------	------------	----------

To assure proper engine lubrication, the engine oil must be maintained at the correct level. Check the oil level at regular intervals, such as once a month. The best time to check the engine oil level is about five minutes after a fully warmed engine is shut off. Checking the oil while the vehicle is on level ground will improve the accuracy of the oil level readings. Maintain the oil level in the "SAFE" range. Adding 1.0 quart (.95 liters) of oil when the reading is at the bottom of the "SAFE" range will result in an oil level at the top of the "SAFE" range on these engines.

NOTICE

- Overfilling or underfilling will cause oil aeration or loss of oil pressure. This could damage your engine.
- Under no circumstances should oil change intervals exceed 6,000 miles (10,000 km) or six months, whichever occurs first.
- Do not use chemical flushes in your engine oil as the chemicals can damage your engine

Coolant

Use only MOPAR Antifreeze/Engine Coolant (OAT coolant conforming to MS.90032) 10 Year/150,000 Mile Formula or equivalent in the engine's cooling system.

NOTICE

- Mixing of engine coolant (antifreeze) other than specified Organic Additive Technology (OAT) engine coolant (antifreeze) may result in engine damage and may decrease corrosion protection. OAT engine coolant is different and should not be mixed with Hybrid Organic Additive Technology (HOAT) engine coolant (antifreeze) or any "globally compatible" coolant (antifreeze). If a non-OAT engine coolant (antifreeze) is introduced into the cooling system in an emergency, the cooling system will need to be drained, flushed, and refilled with fresh OAT coolant (conforming to MS.90032) by an authorized dealer as soon as possible.

- Do not use water alone or alcohol-based engine coolant (antifreeze) products. Do not use additional rust inhibitors or antirust products, as they may not be compatible with the engine coolant.
- This engine has not been designed for use with propylene glycol-based engine coolant (antifreeze). Use of propylene glycol-based engine coolant (antifreeze) is not recommended.

Pedal Learn

Visit a MOPAR dealer to perform the pedal learn function below:

1. Connect a battery charger to the vehicle.
2. Cycle ignition to RUN.
3. Connect the scan tool (wiTECH 2.0).
4. Enter VIN as "111111111111111111".
5. Select "2015" and "LA" (Challenger) as vehicle from drop down menus.
6. Select "PCM."
7. Select "Misc Functions."
8. Select "Learn ETC" and follow on-screen instructions.
9. Cycle ignition key after the successful routine completion.
10. Select "Misc Functions."
11. Select "Cam/Crank Relearn" and follow on-screen instructions.
12. Cycle ignition key after the successful routine completion.

Oil Prime

Ensure proper lubrication within the head of the engine and throughout the valve train. This can be done by removing the head covers. Prior to starting the engine, prime the oil system using a pre-lube engine oiler tank. Fill oil filter with oil and install, then remove oil pressure switch and fit the correct adapter for your pre-lube engine oiler. Ensure there is oil pressure prior to turning engine over. Check oil level and for oil leaks from filter, oil coolers, oil filter adapters and fittings.

Fuel Prime

Turn ignition key to "on" position and leave it on the on position for 3-5 seconds, listen for fuel pump priming. Turn ignition key to "off" position and wait approximately 3 seconds. Repeat this process 5 times. The fuel system should be pressurized now.

WARNING

To prevent SERIOUS INJURY, DEATH or PROPERTY DAMAGE:

Before starting the engine:

- Ensure transmission is in the neutral position
- Secure vehicle with the parking brake or wheel chuck

Start & Check

Once all other procedures above are complete turn engine over using the ignition key. Turn ignition key to "on" position, listen for fuel pump priming, turn ignition key to "start" position and hold until motor start or for 5 seconds maximum. Return key to "on" position and repeat a maximum of 5 times to start



engine. Once engine has started, listen for unusual noises such as engine knock or engine misfires. FEAD drive belts may be noisy at first if tension is not correct or engine is very cold.

Warm Up

Once started the engine will be cold and will idle at a high RPM. Do not depress the accelerator during warm-up stage. The RPM should decrease gradually as temperature increases. The idle RPM will level out and the engine should be running at approximately 200–230°F (93–110°C). Once the engine has reached operating temperature, follow Break-In procedure below.

Break-In

The following tips will be helpful in obtaining optimum performance and maximum durability for your new engine.

Despite modern technology and World Class manufacturing methods, the moving parts of the engine must still wear in with each other. This wearing in occurs mainly during the first 500 miles (805 km) and continues through the first oil change interval. It is recommended for the operator to observe the following driving behaviors during the new engine break-in period:

0 to 100 miles (0 to 161 km):

- Do not allow the engine to operate at idle for an extended period of time.
- Depress the accelerator pedal slowly and not more than halfway to avoid rapid acceleration.
- Drive with the engine speed less than 3,500 RPM.

100 to 300 miles (161 to 483 km):

- Depress the accelerator pedal slowly and not more than halfway to avoid rapid acceleration in lower gears (1st to 3rd gears).
- Drive with the engine speed less than 5,000 RPM.

300 to 500 miles (483 to 805 km):

- Exercise the full engine rpm range, shifting manually (paddles or gear shift) at higher rpms when possible.
- Do not perform sustained operation with the accelerator pedal at wide open throttle.

500 to 1000 miles (805 to 1610 km):

- Exercise the full engine rpm range, shifting manually at higher rpms when possible.
- Do not perform sustained operation with the accelerator pedal at wide open throttle.

For the first 1500 miles (2414 km):

- Do not participate in track events, sport driving schools, or similar activities during the first 1500 mi (2414 km).

NOTE: Check engine oil with every refueling and add if necessary. Oil and fuel consumption may be higher through the first oil change interval. Running the engine with an oil level below the add mark can cause severe engine damage.

Oil Change

The engine oil filter should be replaced with a new filter at every engine oil change. This manufacturer's engines have a full-flow type oil filter. Use a filter of this type for replacement. The quality of replacement filters varies considerably. Only high quality filters should be used to assure most efficient service. MOPAR engine oil filters are a high-quality oil filter and are recommended.

Care should be taken in disposing of used engine oil and oil filters from your vehicle. Used oil and oil filters, indiscriminately discarded, can present a problem to the environment. Contact your authorized dealer, service station or governmental agency for advice on how and where used oil and oil filters can be safely discarded in your area.

Maintenance/Service Schedule

To ensure proper operation of your engine, follow the maintenance interval schedule below. Follow maintenance instructions at the mileage intervals below or time intervals in months, whichever comes first.

Maintenance Intervals	Miles	Or Kilometers	Or Months
Change the engine oil and engine oil filter.	6,000	10,000	6
If using your vehicle for any of the following: dusty or off-road conditions. Clean if necessary.	12,000	20,000	12
Inspect the exhaust system.	12,000	20,000	12
Clean the engine air cleaner filter.	30,000	50,000	30
Inspect and replace the PCV Valve if necessary.	90,000	150,000	90
Replace the spark plugs – 6.4L Engine	96,000	160,000	N/A
Flush and replace the engine coolant.	150,000	240,000	120

Positive Crankcase Ventilation (PCV)

The PCV valve (1) is located at the top right rear of the intake manifold.

1. The PCV valve is sealed to the intake manifold with two O-rings (2).
2. Remove the PCV valve by rotating counterclockwise 90 degrees until the locating tabs (3) have been released.
3. Pull the PCV valve straight up and remove from the intake manifold.
4. Check the condition of the two PCV valve O-rings (2), replace if necessary.
5. Clean the PCV valve mounting surface of the intake manifold opening.
6. Apply engine oil to the two O-rings (2) on the PCV valve.
7. Position the PCV valve (1) into intake manifold and rotate 90 degrees clockwise until the locating tabs are locked in place.

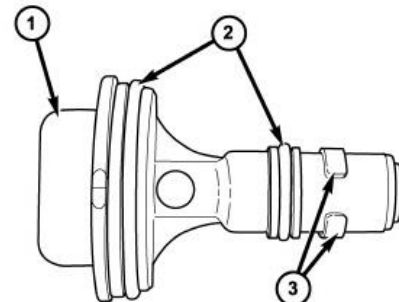
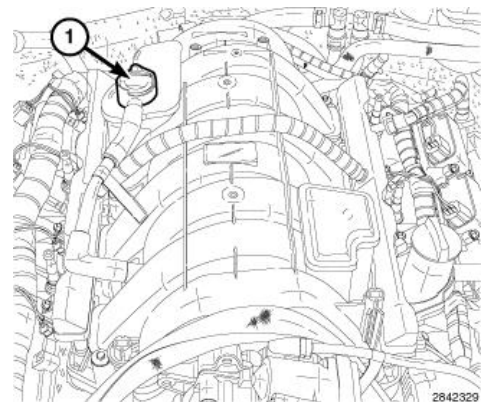

Troubleshooting

Engine does not crank

1. Battery is dead.
2. Clutch interlock switch not properly connected/faulty.
3. Starter not properly connected.
4. Ignition wiring not properly connected.
5. Blown fuse in PDC.
6. Starter does not engage flywheel correctly.
7. Starter is faulty.

Engine Cranks but does Not Start

1. Powertrain fuses open, inspect all fuses, if an open fuse(s) is found, check the related circuit(s) for a short to ground or high resistance, repair issue and replace fuse.
2. Fuel pump delivery; verify that the fuel tank is not empty before continuing. Check fuel delivery system.
3. Check ignition spark.
4. Possible mechanical Issue, engine exhaust system must be free of any restrictions or leaks, engine valve timing must be within specifications, and check for broken timing components, engine compression must be within specifications.

Engine Cranks but runs poorly

1. Disconnected sensor or solenoid.
2. Wrong fuel injector location.
3. Wrong ignition coil location.
4. Inadequate fuel flow.
5. Check the CBID for a MIL, if the MIL is ON: connect to the DLC port and diagnose issue.

Other

Please reference the 2016 Dodge Challenger service manuals to diagnose other issues.

Call MOPAR for assistance if you have any questions regarding the instructions. 1-888-528-HEMI (4364)

French and Spanish Instructions available, please call MOPAR.



SHARE YOUR EXPERIENCE WITH MOPAR!

MOPAR would love to hear your thoughts and experiences! Send us a message on our Facebook page or email us at FCAsocial@fcagroup.com with the subject "392 EC HEMI Engine".