

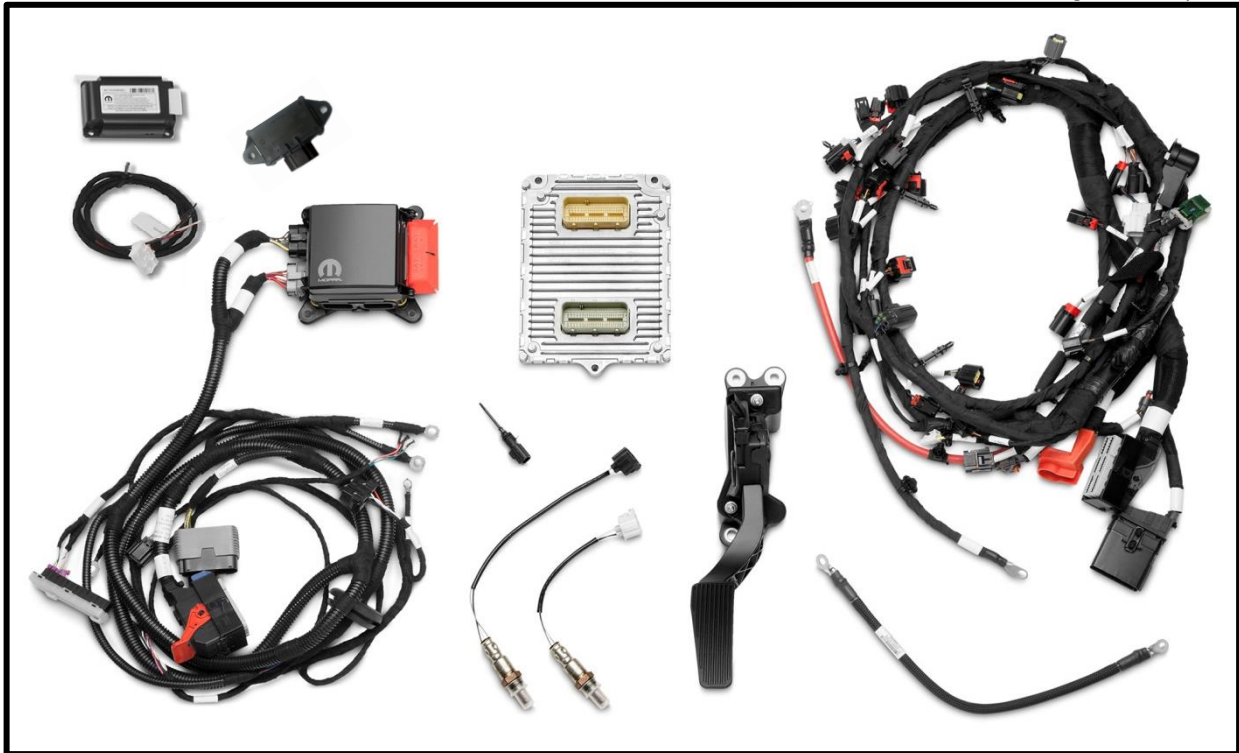

Hellcrate 6.2L Supercharged Crate HEMI® Engine Kit



Pictures show fully dressed engines with optional parts.
Engine sold separately.



TO PREVENT **SERIOUS INJURY AND PROPERTY DAMAGE**, YOU SHOULD READ, UNDERSTAND AND FOLLOW THE WARNINGS AND INSTRUCTIONS IN THIS MANUAL **PRIOR TO INSTALLATION**.
CALL **MOPAR** FOR ASSISTANCE OR FOR FRENCH/SPANISH INSTRUCTIONS **1-888-528-HEMI (4364)**



Contents

Included Parts List	2
Important Safety & Emissions Information.....	3
Drivetrain Requirements	5
Additional Parts.....	6
Component Instructions & Guidelines.....	7
Charge Air Cooler System.....	9
Electrical Connections	15
Break-In/Maintenance	35
Troubleshooting	39

Included Parts List

Part Description	6.2L Part Number	Service Parts	Quantity
PACKAGE	77072452AE		
Crate Engine Wiring/PDC Kit	77072465AC	Yes	1
Powertrain Control Module	P5160160	Yes	1
O2 Wide Sensor	68250166AA	Yes	1
O2 Wide Sensor	68203458AA	Yes	1
Ground Jumper	68060322AG	Yes	1
Accelerator Pedal	04861714AF	Yes	1
Intake Duct	05038817AA	Yes	1
CAI Temperature Sensor	05149279AC	Yes	1
Make Up Air Hose	68166404AC	Yes	1
CAN Bus Interface Device	77072456AB	Yes	1
Fuel Pump Control Module	68193711AC	Yes	1
Instruction Sheet	K6862743AB	Yes	1

NOTE: Revision level (suffix) of part numbers are subject to change.

Engine sold separately:

Hellcrate 6.2L Crate HEMI® engine part number: 68303089AA

This kit and instruction sheet is designed for 2015-2017 model year 6.2L Supercharged engines, part number listed above.

Not compatible with 2018 model year Hellcrate 6.2L Crate HEMI® part number 68303089AB.



Important Safety & Emissions Information

⚠️ WARNING

To prevent SERIOUS INJURY or DEATH:

- ALWAYS wear eye protection and appropriate protective clothing. You may be exposed to flammable, corrosive and hazardous liquids and materials when installing an engine.
- ALWAYS secure the vehicle with the parking break or wheel chock before working on a vehicle.
- If you jack the vehicle, securely support the vehicle using jack stands before working under the vehicle.
- Make sure you or the installer has the appropriate skills and the tool required to safely install the engine.
- If you do not understand the instructions, call MOPAR for assistance at 1-888-528-HEMI (4364).
- NEVER modify wiring in the accelerator pedal system.
- DO NOT connect battery until all connections are made.

DO NOT start or run an engine in a closed garage or in confined area. Exhaust gases contain Carbon Monoxide (CO), which is odorless and colorless. Carbon Monoxide is poisonous and can cause serious injury or death when inhaled.

Follow the precautions below to prevent Carbon Monoxide poisoning:

- DO NOT inhale exhaust gases.
- NEVER run the engine in a closed area, such as a garage, and never sit in a parked vehicle with the engine running for an extended period.



EMISSIONS STATEMENT

Intended Use:

CRATE HEMI® ENGINES ARE DESIGNED FOR INSTALLATION IN

1. ANY MOTOR VEHICLE MANUFACTURED PRIOR TO MODEL YEAR 1976, AND
2. IN ANY VEHICLE THAT LACKS FEATURES CUSTOMARILY ASSOCIATED WITH SAFE AND PRACTICAL HIGHWAY USE THAT IS OPERATED NOT ON A STREET OR HIGHWAY.

IT MAY BE A VIOLATION OF FEDERAL LAW SUBJECT TO CIVIL PENALTY TO INSTALL A CRATE HEMI® ENGINE IN ANY MOTOR VEHICLE DESIGNED FOR TRANSPORT ON A STREET OR HIGHWAY THAT WAS MANUFACTURED IN MODEL YEAR 1976 AND LATER.



Operation and Use Limitations:

- Federal and California law prohibit tampering with emissions control equipment or components required to be equipped on Motor Vehicles. This means that persons may not remove or render inoperative any device or element of design that impairs the emissions of such Motor Vehicles. Violators of this prohibition may be subject to civil penalty.
- Crate HEMI® kits may not be used in place of a regulated or certified nonroad engine (such as in marine applications).
- Installation of a Crate HEMI® engine in violation of these Instructions will void any applicable MOPAR warranty.
- 6.2L engines from 2015-2017 Challenger/Charger may be comparable to a Crate HEMI® engine when installed in appropriate vehicles as referenced above along with the appropriate Crate HEMI® Kit.

Mopar Performance customers are responsible for complying with applicable federal state and local environmental laws and regulations. Many Mopar Performance parts and components are designed to be equipped in vehicles that are operated not on streets or highways (such as vehicles intended for competition or off-road use). Motor Vehicles designed for transport on streets or highways and equipped with such parts may cause such Motor Vehicles to be out of compliance with applicable emissions standards. It may be a violation of federal and state law to operate such Motor Vehicles equipped with such parts, except where vehicles equipped with such parts are operated not on streets or highways and where such vehicles lack features customarily associated with safe and practical highway use.

If you install such parts on a Motor Vehicle, and your Motor Vehicle fails a required state or local inspection and maintenance (I/M) emissions test, including any test required to maintain or renew your Motor Vehicle's registration, or if your Motor Vehicle is subject to an emissions recall, in either case FCA US LLC may not be required to repair your Motor Vehicle under the emissions warranty, and you may be required to remove those parts and replace them with other parts at your own expense in order to obtain repairs necessary to pass the I/M emissions test or to ensure your Motor Vehicle is compliant with applicable emissions standards after the recall repair.

Those parts marked in this catalogue with a superscript 1 before the part number and appropriately marked on their packaging may legally be used on a vehicle that is not operated on streets or highways and that lacks features customarily associated with safe and practical highway use.

Limited Warranty:

Federal law requires emissions parts on new Motor Vehicles and engines to be warranted for at least two years or 24,000 miles, whichever comes first.



Drivetrain Requirements

Axle Drive Ratio

The recommended axle drive ratio should be 2.61:1 to 3.70:1 to obtain optimal vehicle performance and fuel economy. A 230mm Limited Slip Differential (LSD) is recommended for best drivability.

Tire Size

The recommended rear tire size is 28 to 29.5 inches in overall diameter.

Fuel

The fuel grade required for the 6.2L engine is “Premium” (91 octane or greater). The Fuel Pressure Control Module (FPCM) outputs a Pulse Width Modulation (PWM) signal to drive any capable fuel pump. Ensure the selected fuel pump can handle a 14.4 Volt (maximum) PWM input. This system has variable fuel pressure with an operating range from 330 kPa +/- 34.5 kPa (43.5 PSI +/- 5 PSI) to 550 kPa +/- 34.5 kPa (79.8 PSI +/- 5 PSI). Required minimum fuel pump flow at 550kPa is 300 LPH (489 lbs./hr.). Minimum fuel pressure at idle is 330 kPa (43.5 PSI).

NOTICE

Inadequate fuel flow and pressure may result in reduced performance and engine damage. Ensure desired fuel pressure at fuel rail and measured pressure are similar if tools to measure pressure are available. The FPCM controls the correct desired fuel pressure, however a Fuel Pressure Regulator (FPR) will be required for safety to be set at 575kPa (83PSI) for fuel pumps without internal fuel pressure relief valves, for routing information see “Fuel Lines” section on page 13.



Additional Parts

Some additional parts may be needed that are not supplied in this kit to complete the powertrain. Each application is unique and all possibilities and configurations may not be covered in this instruction sheet. These parts can to be ordered separately through your local MOPAR Dealer or an aftermarket supplier.

Front End Accessory Drive (FEAD) Kit

The 6.2L Supercharged crate engine will require a FEAD kit to operate the engine. The basic FEAD kit is part number 77072492, this includes the alternator, power steering pump, and all necessary pulleys, fasteners, and belts. Additionally, the air conditioning kit can be added on to the FEAD, part number 77072493.

Engine Mounts

Engine mounts should be fabricated or purchased from an aftermarket source to fit the specific application. The engine side aluminum mounting brackets that are included on the engine are from a 2017 Dodge Challenger. It is recommended that the engine mounts incorporate production style engine dampers to allow for engine vibrations. The recommended engine installation angle is 2° (rear down).

Oil Pan

The oil pan supplied with the crate engine is a front sump oil pan design from a 2017 Dodge Challenger. Some applications may require an alternate oil pan and pickup configuration.

Transmission

The flywheel and clutch or flex plate and torque converter combinations needed may be unique to the application. A flywheel and clutch assembly from a 2017 Dodge Challenger SRT Hellcat will be included with all crate engines, please utilize the correct combination of parts for the desired drivetrain selected.

Starter

Ensure the correct starter is selected for the transmission and flex plate or flywheel combination. A starter nose spacer may be required for the starter motor to properly engage and spin the engine. The recommended starter for the 6.2L Supercharged Crate HEMI engine with 2017 Dodge Challenger clutch assembly is part number 68066177AA.

Exhaust Manifolds

The 6.2L Supercharged Crate HEMI engine does not come with exhaust manifolds. Since this engine shares the production exhaust manifold bolt pattern, any late model HEMI exhaust manifold/header will bolt up. What manifolds will fit your chassis will depend on your specific installation. We recommend tubular headers with 2" primary diameter for optimum performance. Exhaust manifold kit 77072462AB is available from Mopar.



Component Instructions & Guidelines

Accelerator Pedal

Follow accelerator pedal installation recommended guidelines below. Torque to 7 N·m (5 ft. lbs.). Please refer to the Break-In/Maintenance section for the required pedal learn function.

Label	Description	Minimum Clearance	Maximum Clearance
A	Clutch to Brake	60mm	-
B	Brake to Accelerator	65mm	80mm
C	Accelerator to Transmission Tunnel	35mm	-
D	Accelerator to Brake - Depth	43mm	47mm

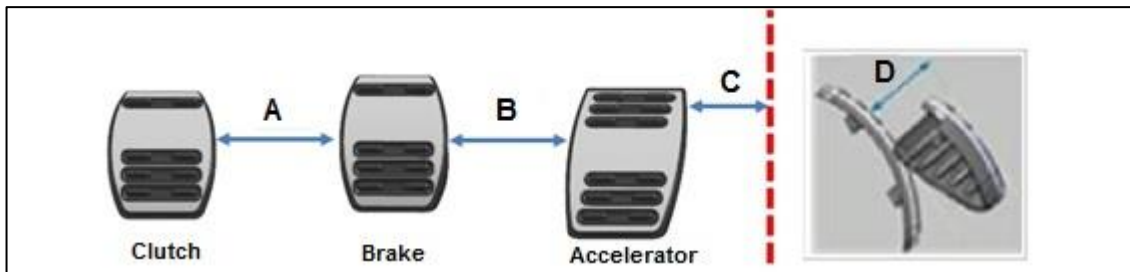

Powertrain Control Module (PCM)

Fasten PCM using the 3 fastener locations on the edges of the PCM. Do not over tighten fasteners as damage may occur on PCM housing. This PCM will not function in a current production vehicle. Connect a ground cable to PCM housing.

NOTICE

The PCM and the engine harness PCM connectors are environmentally sealed. This unit can be mounted anywhere in the vehicle, however it is not recommended to be installed near hot locations such as the exhaust system, on the engine, or high splash areas such as the wheel wells. If routing the wiring harness through the bulkhead or any sheet metal, a grommet is required to prevent damage.

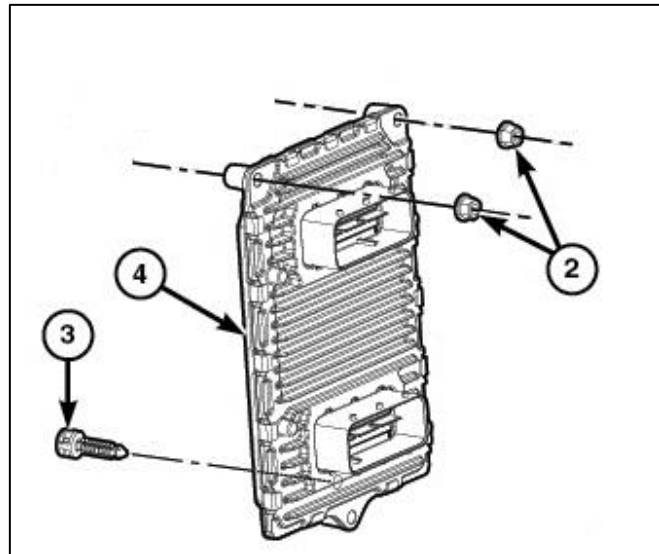

Front End Accessory Drive (FEAD) Systems

Install FEAD kit and FEAD Add-On kits as per their included instruction sheet.

Proper tension must be applied to the serpentine belt. Tensioner must not be against either bump stop and must be applying tension to belt. Use appropriate length belt included within kit or suggested in instruction sheet.



NOTICE

Only use MOPAR Antifreeze/Engine Coolant (OAT coolant conforming to MS.90032) or equivalent in the engine's cooling systems. Only use hoses that are compatible with OAT coolant in the engine's cooling systems. More information can be found in the "Break-In / Maintenance" section.

Coolant Lines & Radiator Fans

Ensure that the correct fan is chosen for the application. This system has a 30 amp maximum fused output for a fan. Mount appropriately sized fans to appropriately sized radiator for the application used. The PCM is programmed to turn the fan ON at 98°C (208°F). Use radiator coolant hoses 45 mm (1.75 inches) inner diameter and fit to the specific application. An additional fitting may be on the water pump, if not in use remove fitting and install an appropriate plug. To achieve full power and torque output engine coolant temperature must be greater than 54°C (129°F).

NOTICE

When installing coolant lines ensure there are no sharp bends that may restrict coolant flow. Use tightly secured clamps on hoses and inspect for leaks. Adequate engine cooling is necessary to prevent damage to engine. Vacuum filling the cooling system is recommended. No air bubbles should be trapped within coolant lines, bleed system correctly. Do not run engine above 116° C (240° F). Normal temperature range is 93–110°C (200–230°F). Maximum engine coolant temperature is 120°C (248°F), protection and reduced torque and power modes will apply when engine coolant temp exceeds 120°C (248°F) to protect engine from damage.

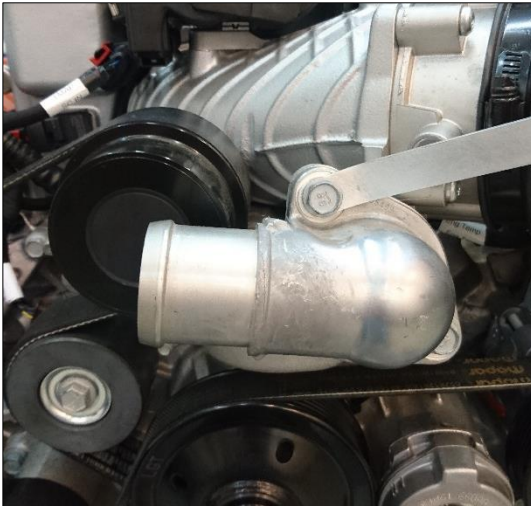

Rear Heater Lines

If bypassing heater core, recirculate coolant lines at the back of the engine by connecting one side of coolant line to the other using an appropriate length of hose to ensure no sharp bends are present and fasten with hose clamps. Use 5/8 inch inner diameter hose. If using a heater core, coolant line flow is as follows: inlet on right and outlet on left.

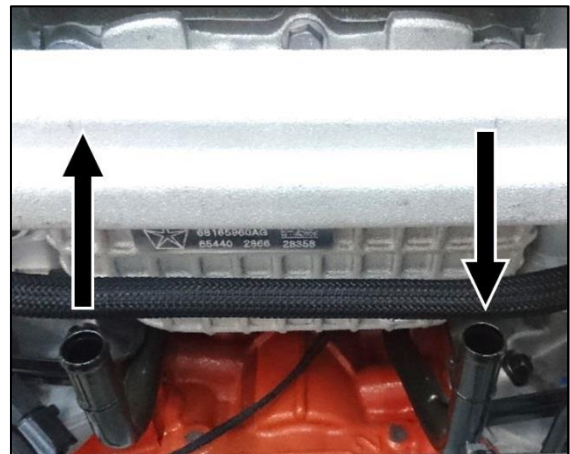



Charge Air Cooler (CAC) System

Charge Air Cooler Inlet & Outlet

The charge air cooler coolant inlet and outlet are located on the rear right of the supercharger assembly. The inlet is the lower fitting and the outlet is the upper fitting. Use 19mm (3/4 inch) inner diameter hose. A bleed valve is located above the upper charger air coolant line.

NOTICE

When installing coolant lines ensure there are no sharp bends that may restrict coolant flow. Use tightly secured clamps on hoses and inspect for leaks. Vacuum filling the cooling system is recommended. No air bubbles should be trapped within coolant lines, bleed system correctly.

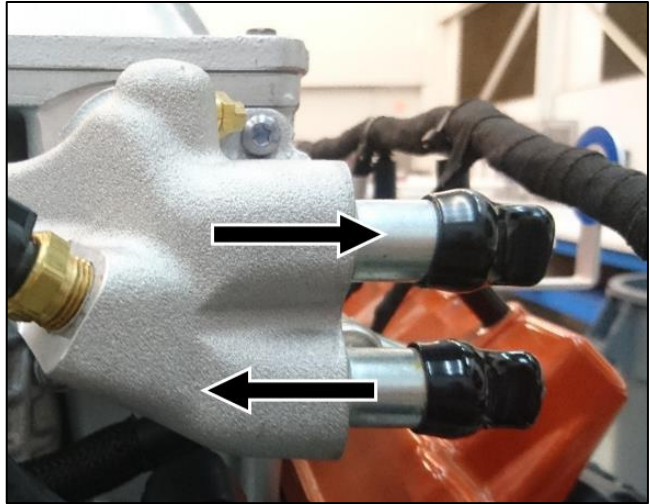

Charge Air Cooler Pump

A charge air cooler pump is required; recommended output is 45 L/min (11.89 gal/min) at 150 kPa (21.76 PSI). Inlet and outlet recommended to be 25 mm (1 inch) inner diameter. The connector is intended for a 2017 Dodge Challenger pump; part number 05181868AF. This charge air cooler pump is controlled via the LIN bus from the PCM, there are three modes of operation; OFF, ON, and ON while ignition is OFF. An aftermarket pump that meets the recommended specifications can be used, however it will not be controlled via LIN bus.

Charge Air Cooler Reservoir

The charge air cooler reservoir should have a recommended capacity of 1023 ml (34.6 oz.) including the volume for fluid expansion, the maximum cold fill volume of 823mL (27.8 oz.), and be fitted with a pressure cap capable of 124.1 kPa (18 PSI). Install the charge air cooler reservoir in line with the outlet of the supercharger housing. Use 25mm (1 inch) diameter hose and lines. 2017 Dodge Challenger reservoir can be used if desired, part number 05181870AF.

Low Temperature Radiator (LTR)

The 2017 Dodge Challenger cooling system is comprised of two low temperature radiators in series. The main LTR also contains a transmission cooler in the lower half. The main LTR is a single row 628x296x22 mm (24.7x11.7x0.87 inch) cooler and the auxiliary LTR is a triple row 220x150x43.5mm (8.66x5.90x1.71 inch) cooler. The pressure loss across both radiators combined is 62.2 kPa (9.02 PSI) at a flow of 25 L/min. Use the actual pressure loss and dimensions as a guide when selecting an appropriate LTR(s) for the application.

Recommended inlet and outlet diameters of 25 mm (1 inch).

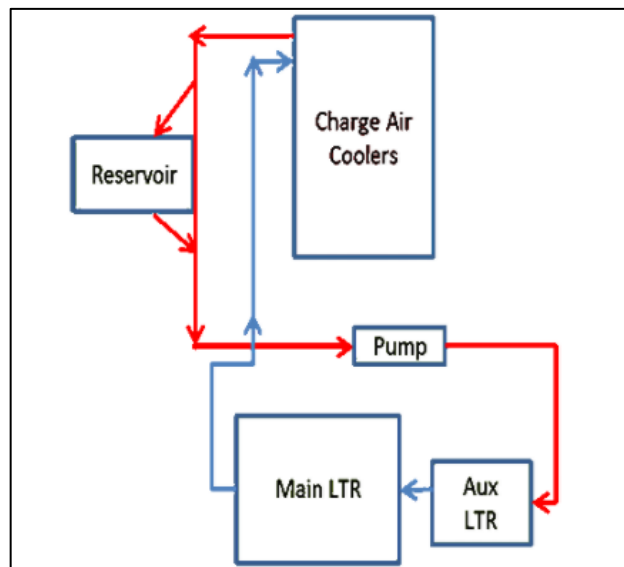



Hellcrate 6.2L Supercharged Crate HEMI® Engine Kit Instruction Sheet

www.mopar.com

The 2017 Dodge Challenger LTR system is recommended, however it may require modification to the vehicle to fit correctly. Part numbers for the production system are listed below:

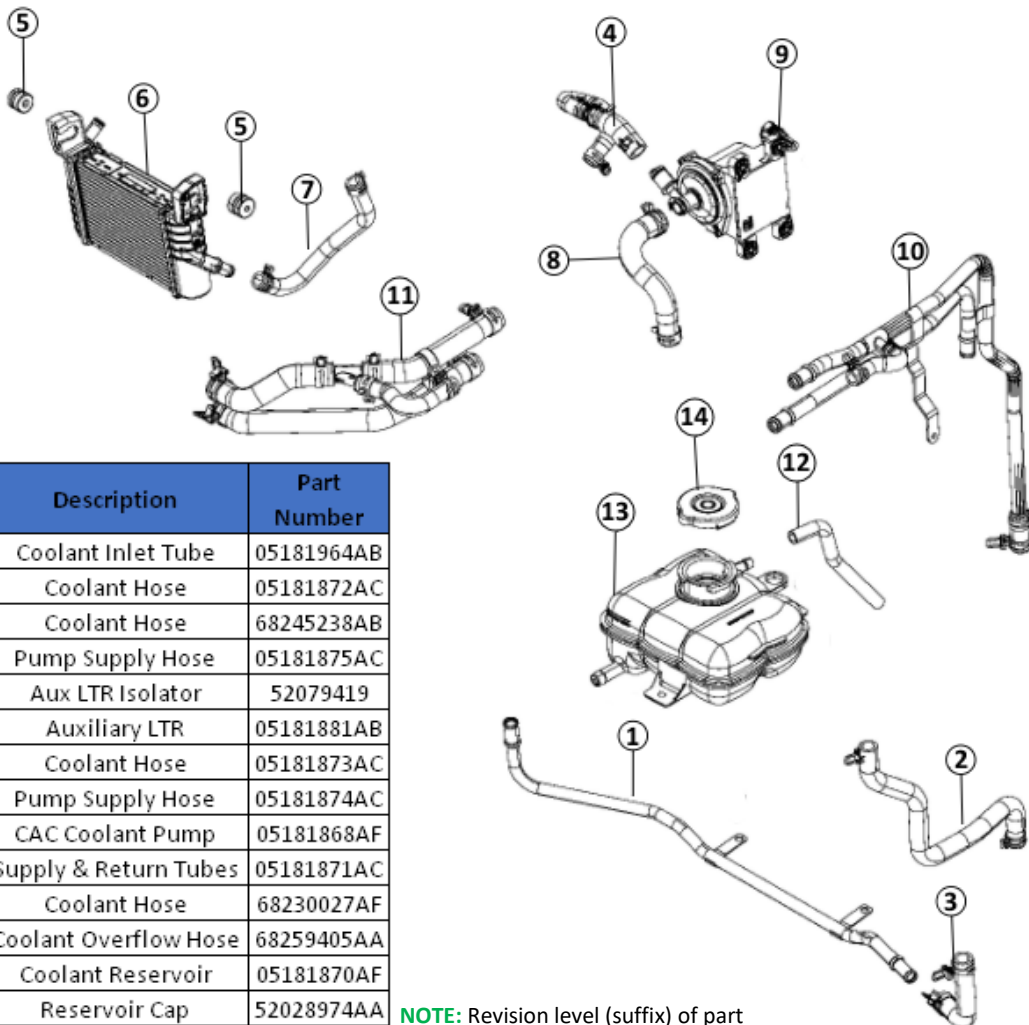
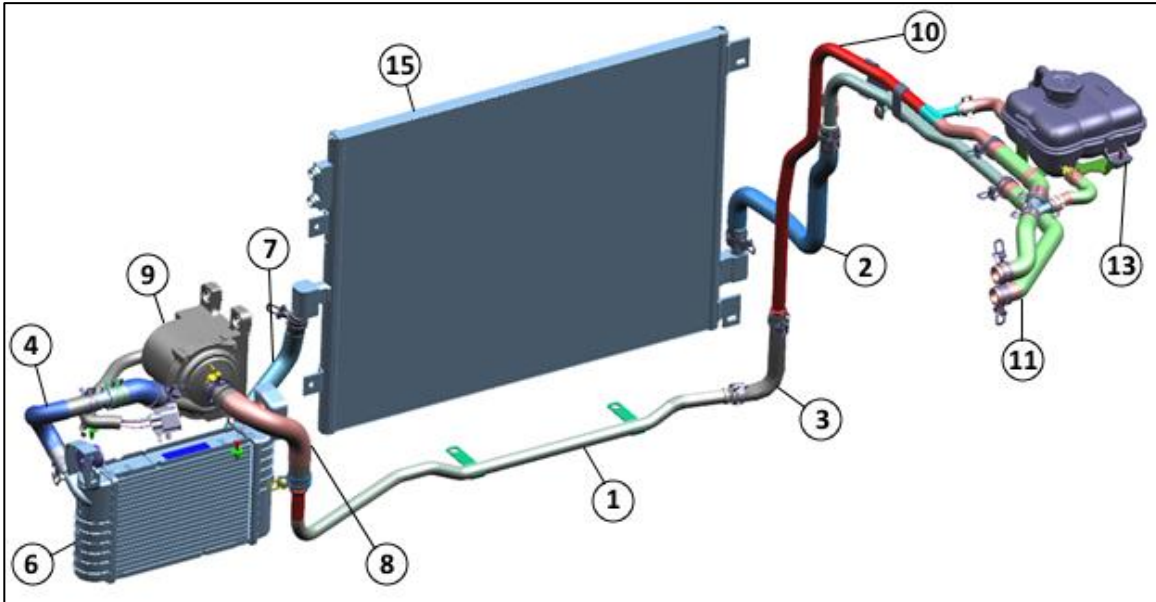

Call Out	Description	Part Number
1	Coolant Inlet Tube	05181964AB
2	Coolant Hose	05181872AC
3	Coolant Hose	68245238AB
4	Pump Supply Hose	05181875AC
5	Aux LTR Isolator	52079419
6	Auxiliary LTR	05181881AB
7	Coolant Hose	05181873AC
8	Pump Supply Hose	05181874AC
9	CAC Coolant Pump	05181868AF
10	Supply & Return Tubes	05181871AC
11	Coolant Hose	68230027AF
12	Coolant Overflow Hose	68259405AA
13	Coolant Reservoir	05181870AF
14	Reservoir Cap	52028974AA
15	Main LTR	68272789AA

NOTE: Revision level (suffix) of part numbers are subject to change.



NOTICE

The LTR of your choice should provide sufficient cooling performance for the engine. Insufficient cooling can result in power loss or engine damage. When Temperature & Manifold Absolute Pressure (TMAP) sensor temperature reaches calibrated values, the PCM will enter lower torque and power output modes to protect engine from damage. Sensor temperature values are listed below.

Intermediate Manifold Air Temp (IMAT) Sensors

Will reduce torque output once temperature goes above 148°C (298°F) to protect engine from damage.

The intermediate TMAP (IMAT) sensor is located on the upper left side of the supercharger.



Air Charge Temperature (ACT) Sensors (2 Sensors)

Will reduce torque output once temperature goes above 99°C (210°F) to protect engine from damage.

Bank 2 TMAP (ACT) sensor is located on the right front bottom of the supercharger.



Bank 1 TMAP (ACT) sensor is located on the left rear bottom of the supercharger.





Intake System

Install the intake duct hose included (05038817AA) as pictured below. To install an intake filter, fabricate a 114 mm (4.5 inch) intake tube to fit your vehicle's space constraints. The intake filter must be within 600 mm (23.6 inch) of the throttle body. A bracket may be needed to support the intake filter tube and fasten to an appropriate location. An intake filter must be installed; recommended filter is part number 77072491. This filter was specifically designed for the 6.2L Supercharged crate engine's flow and filtration requirements. Ensure there is adequate air flow to the intake filter. Ensure intake system is fastened correctly and no leaks are present. Install the charge air temperature sensor to tube within 152 mm (6 inches) of the throttle body. Use a 1/2-inch ID rubber grommet when installing charge air temperature sensor into the intake tube.

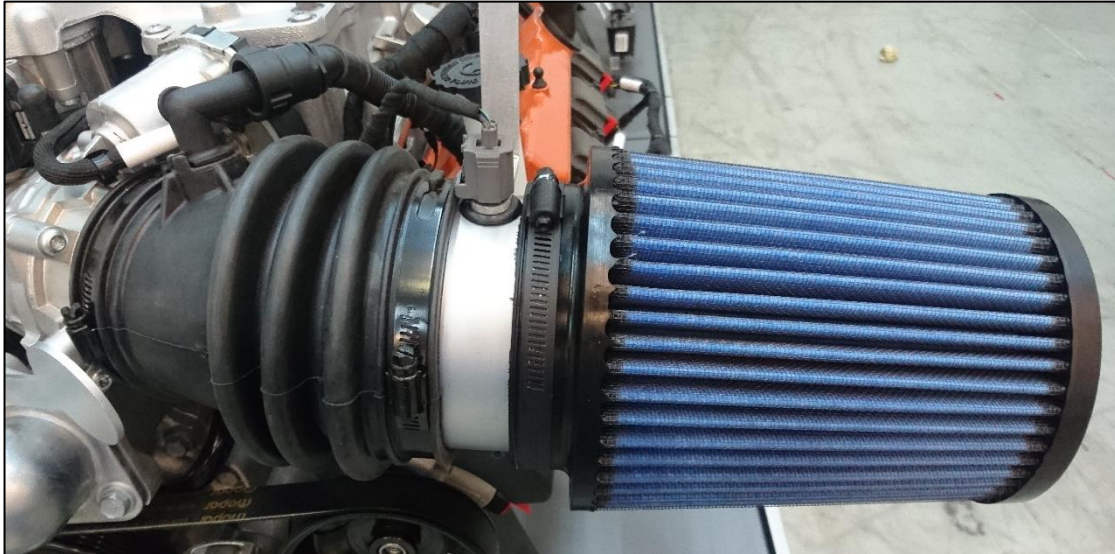

Make-Up Air

Connect the make-up air hose to the left side valve cover make-up air nipple and the intake air duct. The hose has quick release fittings pre-installed, ensure the fitting is fully seated onto the nipple on the intake duct and the valve cover.





Fuel Lines

Fuel injectors and fuel rail will come pre-installed on crate engine. The fuel rail is a non-return style fuel rail. Use only fuel grade hoses and fittings when installing fuel system. Fuel rail inlet size is 1/2 inch SAE quick release. Fuel pump requirements are outlined on page 5. The FPCM controls the correct desired fuel pressure, however a Fuel Pressure Regulator (FPR) will be required for safety to be set at 83 PSI for fuel pumps without internal fuel pressure relief valves. The FPR should be placed prior to fuel inlet on fuel rail. Follow diagram below for FPR layout. A fuel pump module with an internal pressure relief valve or external FPR should be set at a pressure of 575kPa (83PSI).

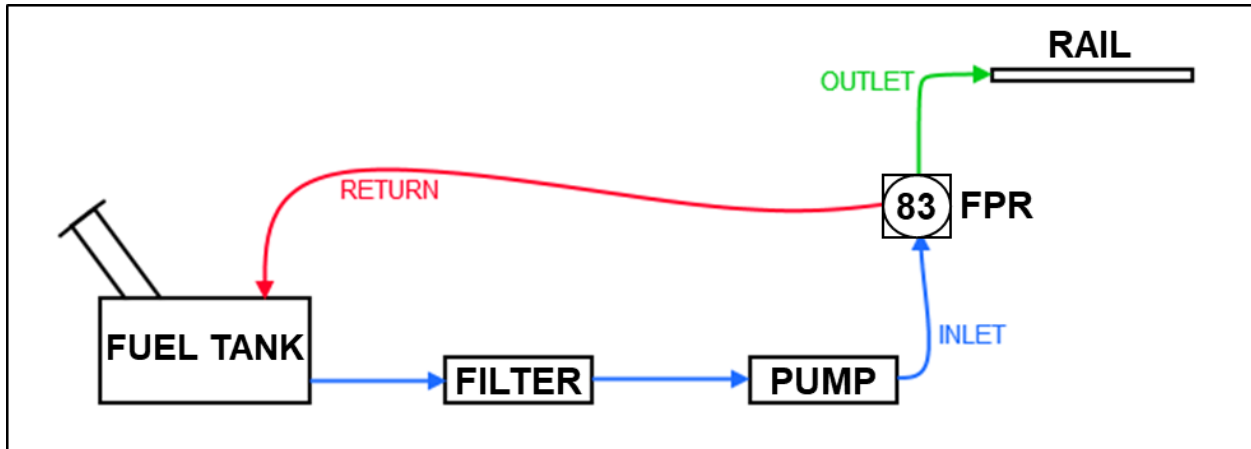

Vacuum

Vacuum reference can be taken at the fitting at the front of the supercharged housing, below the throttle body or on top, behind the throttle body. These can be used as the brake booster vacuum line or any other vacuum reference needed. If not being used, cap these fittings with a 3/8 inch inner diameter vacuum hose cap.

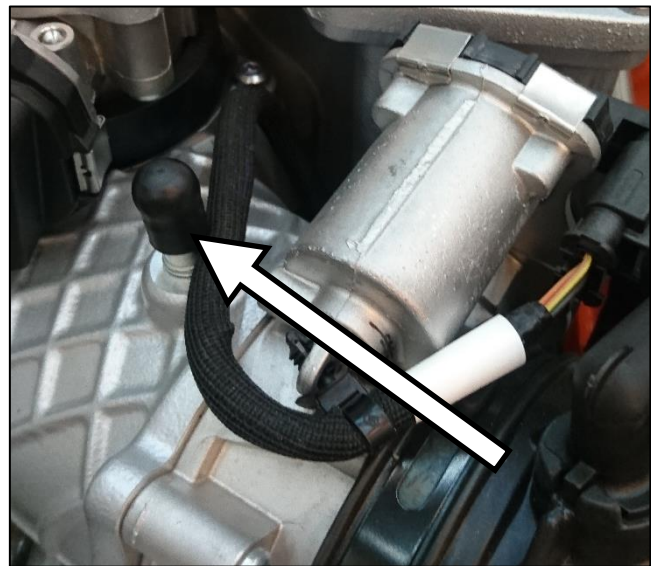



Oil Filter Adapter & Cooler

An oil cooler is required for this engine to maintain safe oil temperatures. To utilize the oil cooler adapter, connect oil lines to the two quick disconnect oil fittings, if required alternative fittings can be installed; 1-1/16" -12 ORB fittings can be installed in the oil cooler adapter.

When selecting an aftermarket oil cooler, it is advised to follow a recommended oil cooler maximum pressure loss of 24.1 kPa (3.50 PSI) at 30 L/min without oil cooler lines, and 30.0 kPa (4.35 PSI) at 30 L/min with oil cooler lines, using the recommended 0W40 oil. Recommended dimensions are 222x160x51 mm (8.75x6.30x2.00 inch).



The 2017 Dodge Challenger oil cooler can be used; part number 05181879AD. The production oil cooler, shown on the right, comes with quick disconnect oil fittings, however if required these fittings can be removed and alternative 1-1/16" -12 ORB fittings can be installed.

To achieve full power and torque output engine oil temperature must be greater than 20°C (68°F).

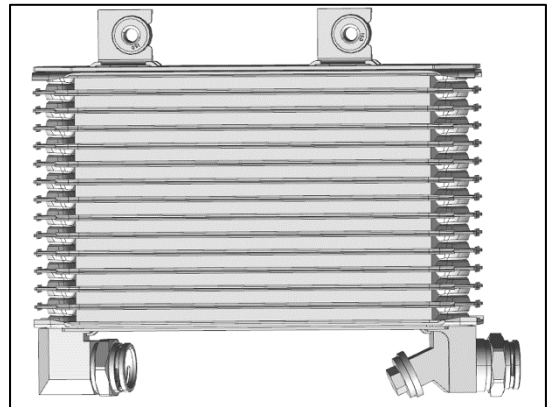

NOTICE

Ensure oil cooler has sufficient air flow. Maximum engine oil temperature is 161°C (322°F), protection and reduced torque and power modes will apply when engine oil temp exceeds 161°C (322°F) to protect engine from damage. Ensure adequate oil cooling is applied using an oil cooler.



Electrical Connections

WARNING

To prevent SERIOUS INJURY or DEATH:

- Make sure you or the installer has the appropriate skills and the tool required to safely install the engine.
- If you do not understand the instructions, call MOPAR for assistance at 1-888-528-HEMI (4364).

Engine Harness

Ensure all connectors are connected in their appropriate location and are in the locked position. The pages below show all the engine and chassis connectors. Follow wiring instructions carefully.

NOTICE

- Ensure the wiring harness is secured every 100 mm (4 inches) and routed to avoid potential damage to the wiring. Make sure any unused wiring is properly secured and protected.
- Some cavities in the PCM and inline connectors may be populated with wires, however those wires are not in use. See pinouts for circuits used.
- All connector diagrams are in wire insertion view.
- To diagnose a wiring issue outside of this manual, use 2017 Dodge Challenger service information.
- All grounds must be clean and secure. No paint can be present between the ground and body contact point. There are multiple grounding points on the engine and chassis side harnesses, as well as an engine grounding cable part number 68060322AG. This part is to be fastened on one end to the engine block and the other end to the vehicle's chassis, there should not be tension in the Ground Jumper.
- Soldering connections and wire splicing instruction can be viewed on the final page of the wiring section.

Code	Color	Code	Color	Code	Color	Code	Color	Code	Color
BK	Black	GN	Green	VT	Violet	DB	Dark Blue	LB	Light Blue
BU	Blue	GY	Gray	WT	White	DG	Dark Green	LG	Light Green
BR	Brown	OG	Orange	YL	Yellow	TN	Tan	PK	Pink
RD	Red								

Capacitors

As part of the ignition system there are 2 capacitors on the back of the engine, one on each side bolted to the cylinder head. Plug in the connectors for both capacitors. The capacitors have a 2 pin connector.

Pin	Function	Color	GA
1	FUSED ASD RELAY OUTPUT	BR/YL	16

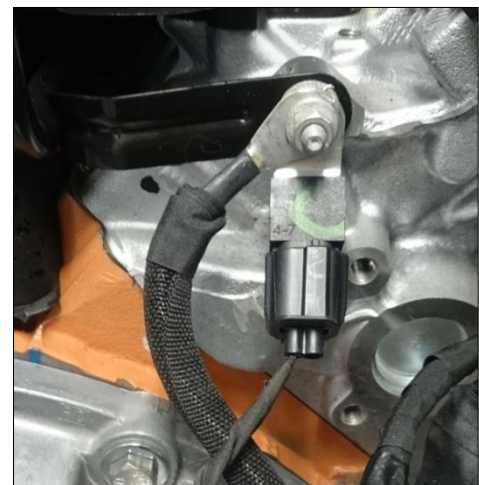

All diagrams are wire insertion view



Ignition & Fuel

There are 8 coil plug connectors and 8 fuel injector connectors, 4 on each side. Ensure that the correct plug is connected for each cylinder to avoid misfires. The engine's firing order is 1-8-4-3-6-5-7-2.

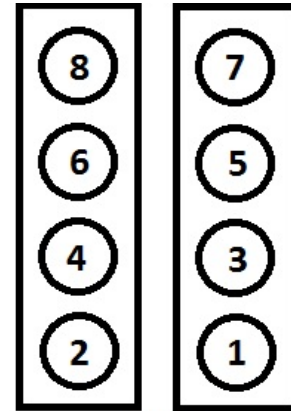

Front
Engine Harness Layout
for Ignition and Fuel Injection

Coil Plug Connectors (3 pin)

Pin	Function	Color	GA
Coilpack 1			
1	COIL CONTROL 1	DB/DG	16
2	FUSED ASD RELAY OUTPUT	BR/YL	16
3	NO CONNECT	NA	
Coilpack 2			
1	COIL CONTROL 2	DB/TN	16
2	FUSED ASD RELAY OUTPUT	BR/YL	16
3	NO CONNECT	NA	
Coilpack 3			
1	COIL CONTROL 3	DB/OG	16
2	FUSED ASD RELAY OUTPUT	BR/YL	16
3	NO CONNECT	NA	
Coilpack 4			
1	COIL CONTROL 4	DB/GY	16
2	FUSED ASD RELAY OUTPUT	BR/YL	16
3	NO CONNECT	NA	
Coilpack 5			
1	COIL CONTROL 5	DB/YL	16
2	FUSED ASD RELAY OUTPUT	BR/YL	16
3	NO CONNECT	NA	
Coilpack 6			
1	COIL CONTROL 6	DB/OG	16
2	FUSED ASD RELAY OUTPUT	BR/YL	16
3	NO CONNECT	NA	
Coilpack 7			
1	COIL CONTROL 7	BR	16
2	FUSED ASD RELAY OUTPUT	BR/YL	16
3	NO CONNECT	NA	
Coilpack 8			
1	COIL CONTROL 8	DB/YL	16
2	FUSED ASD RELAY OUTPUT	BR/YL	16
3	NO CONNECT	NA	

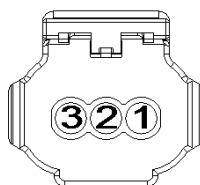

Fuel Injector Connectors (2 pin)

Pin	Function	Color	GA
Fuel Injector 1			
1	INJECTOR CONTROL 1	BR/YL	20
2	ASD CONTROL OUTPUT	BR	16
Fuel Injector 2			
1	INJECTOR CONTROL 2	BR/DB	20
2	ASD CONTROL OUTPUT	BR	16
Fuel Injector 3			
1	INJECTOR CONTROL 3	BR/BU	20
2	ASD CONTROL OUTPUT	BR	16
Fuel Injector 4			
1	INJECTOR CONTROL 4	BR/TN	20
2	ASD CONTROL OUTPUT	BR	16
Fuel Injector 5			
1	INJECTOR CONTROL 5	BR/OG	20
2	ASD CONTROL OUTPUT	BR	16
Fuel Injector 6			
1	INJECTOR CONTROL 6	BR/VT	20
2	ASD CONTROL OUTPUT	BR	16
Fuel Injector 7			
1	INJECTOR CONTROL 7	BR/YL	20
2	ASD CONTROL OUTPUT	BR	16
Fuel Injector 8			
1	INJECTOR CONTROL 8	BR/BU	20
2	ASD CONTROL OUTPUT	BR	16

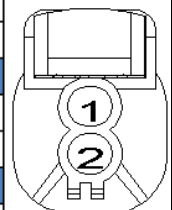

All diagrams are wire insertion view



Starter Motor

There are 2 connections to be made for the starter, the starter battery connector and the starter solenoid connector. These wires will need to be extended if the starter will be placed on the driver side of the vehicle. The starter battery connector eyelet may not be compatible with all starter options. The eyelet may be replaced with an alternative eyelet.

Pin	Function	Color	GA
1	STARTER RELAY OUTPUT	YL/GY	14

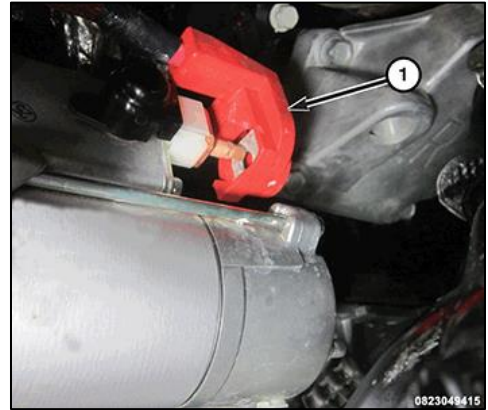

Alternator

The alternator has 2 connectors, the alternator connector and the alternator battery connector. Once the eyelet for the alternator battery connector is properly fastened in place, ensure that the cover is securely in place to avoid accidental connections to this terminal.

Pin	Function	Color	GA
1	GEN FIELD CONTROL	BR/GY	18
2	GEN SENSE	RD/VT	18



Engine Sensors

The knock sensors are bolted onto both sides of the engine block. They are located underneath the exhaust manifolds. Plug in the 2 pin connector to each knock sensor.

Pin	Function	Color	GA
Knock 1			
1	KS 1 SIGNAL	DB/YL	20
2	KS 1 RETURN	BR/LG	20
Knock 2			
1	KS 2 SIGNAL	BR/WT	20
2	KS 2 RETURN	WT/BR	20

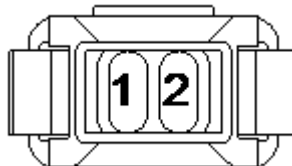

All diagrams are wire insertion view



Charge air temperature sensor is to be plugged in at the air intake, ensure that there is little to no tension on this sensor pigtail as this may damage sensor and sensor plug. A hole may be drilled into the intake tube up to 152 mm (6 inches) away from the throttle body for installation.

Pin	Function	Color	GA
1	INTAKE AIR TEMP SIGNAL	DB/LG	20
2	SENSOR GROUND	BR/WT	20

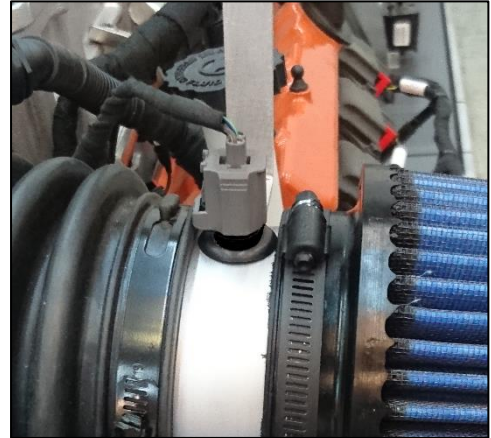
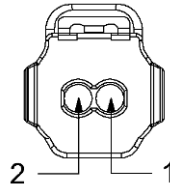

Crank position sensor, labeled “CKP”, is located on the passenger side of the engine near the bell housing flange. It is installed onto the engine block and has a 3 pin brown connector.

Pin	Function	Color	GA
1	5 VOLT SUPPLY	PK/YL	20
2	CKP GROUND	DB/GY	20
3	CKP SIGNAL	BR/LB	20

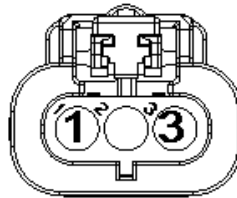

Cam Position Sensor, labeled “CMP” is a 3 pin connector that is located behind the supercharger belt tensioner.

Pin	Function	Color	GA
1	5 VOLT SUPPLY	YL/PK	20
2	SENSOR GROUND	DB/DG	20
3	CMP SIGNAL	DB/GY	20

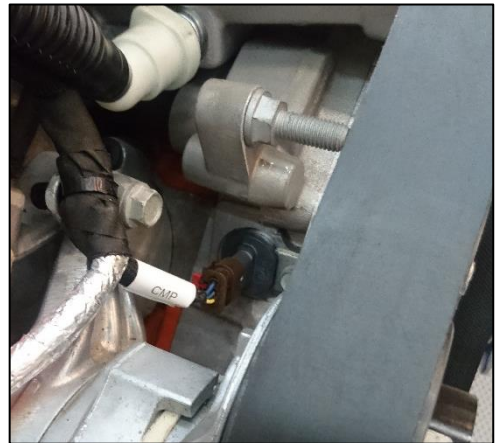
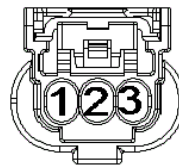

All diagrams are wire insertion view



Oil temperature and pressure sensor are connected near the oil filter location. The oil temperature sensor is facing the passenger side of the block and is directly above the filter location. The oil pressure sensor is located higher and to the right of the oil temperature sensor, it is plugged in facing the front of the engine.

Oil Pressure			
Pin	Function	Color	GA
1	5 VOLT SUPPLY	PK/YL	20
2	OIL PRESSURE SIGNAL	VT/GY	20
3	SENSOR GROUND	DB/DG	20
Oil Temp			
Pin	Function	Color	GA
1	SENSOR GROUND	BR/WT	20
2	ENGINE OIL TEMP SIGNAL	VT/BR	20

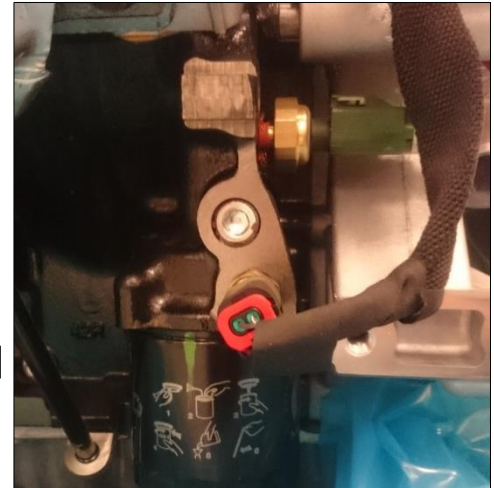
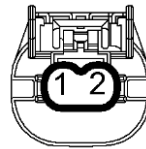
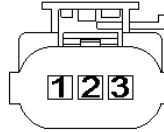

Coolant temperature sensor, labeled “Eng Temp” has a 2 pin connector on the front of the block under the throttle body.

Pin	Function	Color	GA
1	ECT SIGNAL	VT/OR	20
2	SENSOR GROUND	BR/WT	20

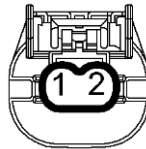

Fuel rail pressure sensor has a 3 pin connector (1) located on the right side fuel rail, behind the fuel rail inlet fitting. This sensor gives the PCM feedback on desired versus actual fuel pressure at the fuel rail.

Pin	Function	Color	GA
1	FUEL PRESSURE SIGNAL	BR/DB	20
2	SENSOR GROUND	DB/DG	20
3	5 VOLT SUPPLY	YL/PK	20

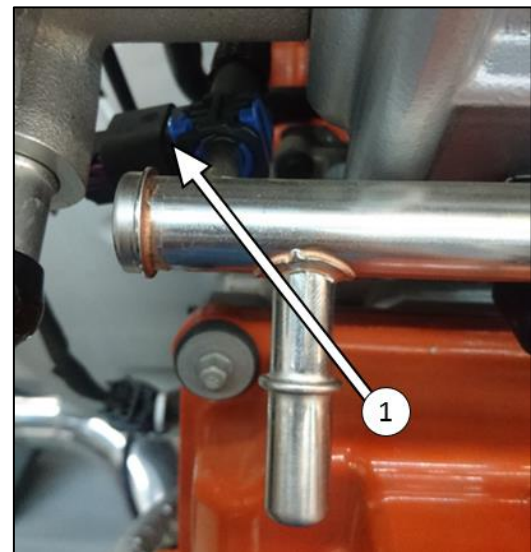
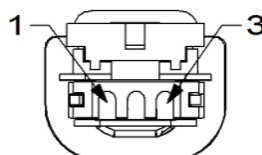

All diagrams are wire insertion view



Supercharger coolant temperature sensor has a 2 pin connector and is located on the back of the supercharger, across from the supercharger coolant inlet and outlet.

Pin	Function	Color	GA
1	CAC SIGNAL	BR/GN	18
2	SENSOR GROUND	DB/DG	20

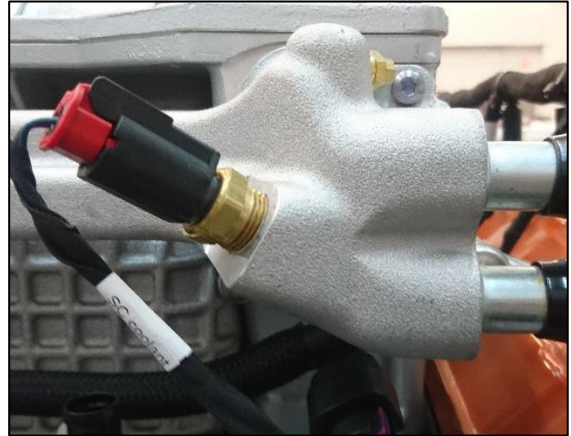
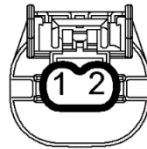

There are 4 Temperature & Manifold Absolute Pressure (TMAP) Sensors located on the supercharger. Each 4 pin TMAP sensor connector must be connected in the correct corresponding TMAP sensor.

TMAP Bank 1 (ACT) sensor is located on the left rear bottom of the supercharger.

Pin	Function	Color	GA
1	SENSOR GROUND	DB/DG	20
2	BANK 1 TEMP SIGNAL	DB/BU	20
3	5 VOLT SUPPLY	YL/PK	20
4	BANK 1 MAP SIGNAL	BR/OG	20



TMAP Bank 2 (ACT) sensor is located on the right front bottom of the supercharger.

Pin	Function	Color	GA
1	SENSOR GROUND	DB/DG	20
2	BANK 2 TEMP SIGNAL	DB/GN	20
3	5 VOLT SUPPLY	YL/PK	20
4	BANK 2 MAP SIGNAL	BR/BU	20

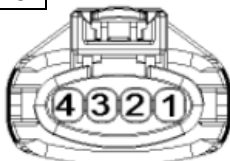

All diagrams are wire insertion view



Hellcrate 6.2L Supercharged Crate HEMI® Engine Kit Instruction Sheet

www.mopar.com

Supercharger outlet TMAP (IMAT) is located on the top of the supercharger cover on the left side.

Pin	Function	Color	GA
1	SENSOR GROUND	DB/DG	20
2	SC OUTLET TEMP SIGNAL	VT/BU	18
3	5 VOLT SUPPLY	YL/PK	20
4	SC OUTLET MAP SIGNAL	VT/YL	18



Supercharger inlet TMAP is located under the supercharger bypass valve connector on the right of the supercharger.

Pin	Function	Color	GA
1	SENSOR GROUND	DB/DG	20
2	SC INLET TEMP SIGNAL	DB/TN	20
3	5 VOLT SUPPLY	YL/PK	20
4	SC INLET MAP SIGNAL	VT/BR	20

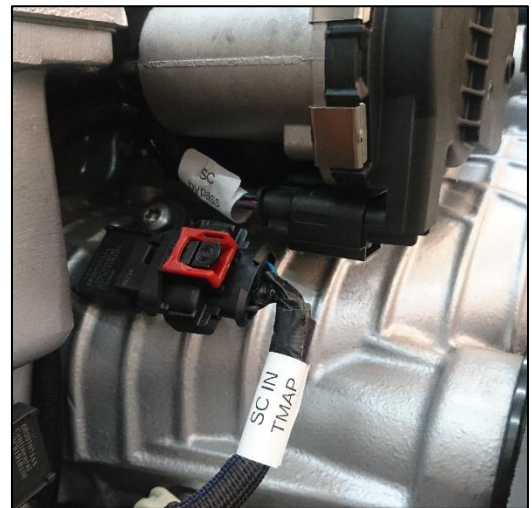

All diagrams are wire insertion view



Throttle Body

Throttle position is a 6 pin connector that is on the throttle body assembly. Do not modify any wiring in this connector.

Pin	Function	Color	GA
1	ETC MOTOR (+)	TN/YL	18
2	ETC MOTOR (-)	TN/OR	18
3	TP 2 SIGNAL	BR/DG	20
4	5 VOLT SUPPLY	PK/YL	20
5	TP 1 SIGNAL	BR/OR	20
6	TP SENSOR RETURN	BR/DB	20

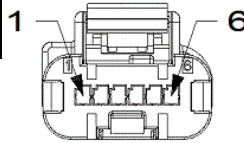

Supercharger Bypass Valve

The supercharger bypass valve is located in front and center of the supercharger cover. The 6 pin connector is located above the inlet TMAP sensor.

Pin	Function	Color	GA
1	SCB VALVE CONTROL (+)	VT/OG	20
2	SCB VALVE CONTROL (-)	VT/GY	20
3	SCB VALVE SIGNAL 2	DB/OG	20
4	5 VOLT SUPPLY	PK/YL	20
5	SCB VALVE SIGNAL 1	DB/GY	20
6	SENSOR GROUND	BR/WT	20

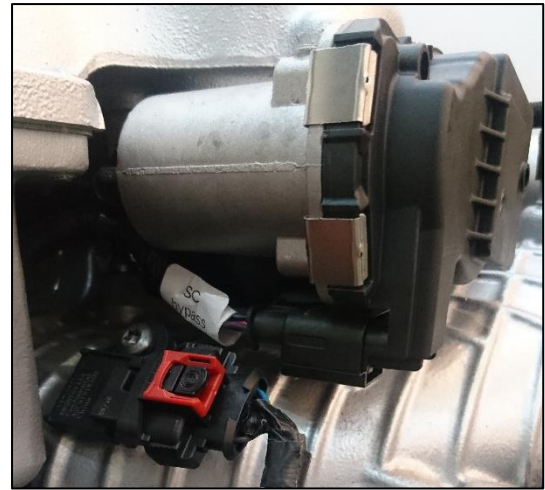
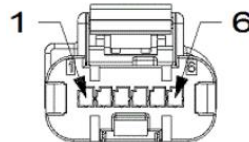

Variable Cam Timing (VCT)

The VCT solenoid is located under the intake manifold. This will remain connected on the engine, connect the VCT inline 6 pin connector.

VCT Inline			
Pin	Function	Color	GA
1	VCT CONTROL	DB	20
2	GROUND	BK	20
VCT			
Pin	Function	Color	GA
1	GROUND	BK	20
2	VCT CONTROL	DB	20

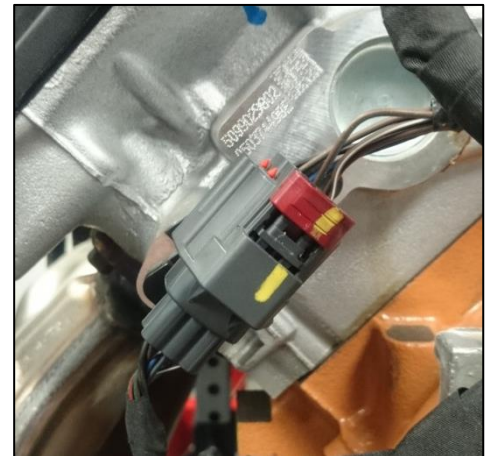
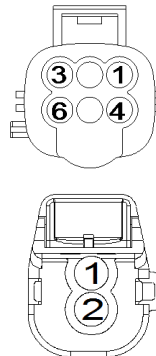

All diagrams are wire insertion view



O2 Sensors

The threads of the new oxygen sensors are factory coated with anti-seize compound to aid in removal. Do not add any additional anti-seize compound to threads of a new oxygen sensor. Install the oxygen sensor (1) into the exhaust manifold and tighten to the proper to 52 N·m (38 ft. lbs.). Connect the oxygen sensor wire harness connector (2) and secure the wire harness to an appropriate location (3).

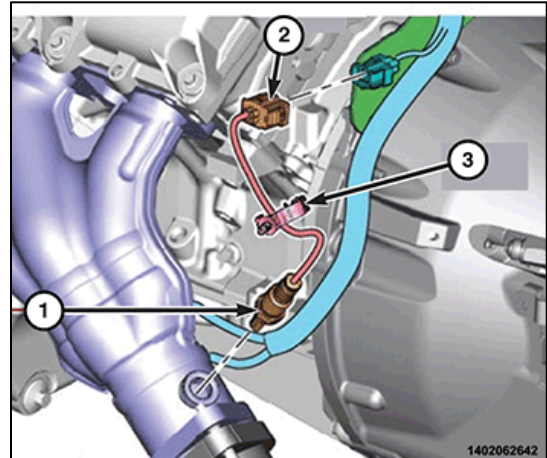

Upstream (Left & Right)

Pin	Function	Color	GA
O2 1/1 Front			
1	O2 RETURN UPSTREAM	BR/DG	20
2	O2 1/1 SIGNAL	DB/BU	20
3	O2 1/1 POSITIVE CURRENT CONTROL	BR/GN	18
4	NO CONNECT	NA	0
5	O2 1/1 HEATER CONTROL	BR/BU	16
6	GROUND	BK	16
7	O2 1/1 PUMP CELL CURRENT TRIM	BR/BU	20
8	NO CONNECT	NA	0
O2 2/1 Front			
1	O2 2/1 RETURN	GY/DG	20
2	O2 2/1 SIGNAL	DB/GN	20
3	O2 1/2 PUMP CURRENT	BR/DG	18
4	NO CONNECT	NA	0
5	O2 1/2 HEATER CONTROL RETURN	BR/TN	16
6	GROUND	BK	16
7	O2 1/2 PUMP CELL CURRENT TRIM	BR	20
8	NO CONNECT	NA	0

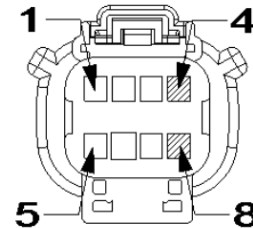

All diagrams are wire insertion view



Fuel Pump Harness & Fuel Pump Control Module (FPCM)

The fuel pump harness is an additional harness to the body harness, needed only if a PWM controlled variable pressure fuel pump and fuel delivery is desired. A PWM controlled fuel pump with variable pressure is highly recommended. If not using the fuel pump harness, diagnostic trouble codes may be present.

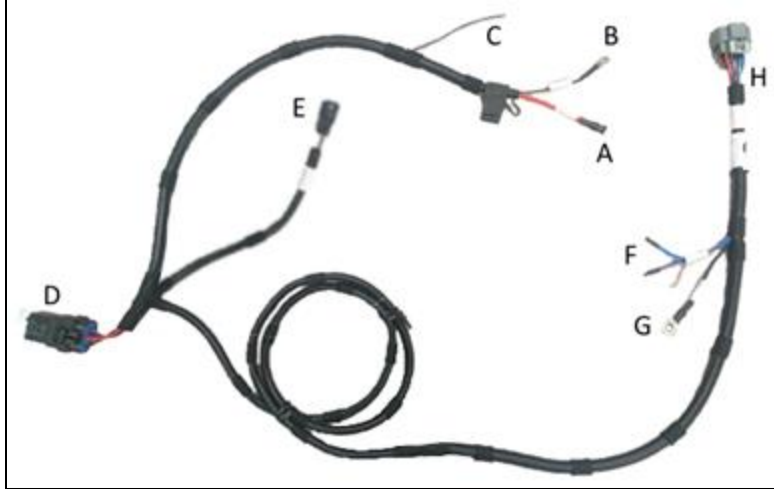

Call Out	Connector
A	FPCM Battery Power
B	Relay Ground
C	Blunt Lead
D	Relay
E	Fuel Mod Control
F	Fuel Pump
G	FPCM Ground
H	FPCM

A – Color: RED – Gauge: 10 – Battery: Connect to battery, constant power supply. (30A fuse)

B – Color: BK – Gauge: 18 – Ground.

C – Color: BU/OG – Gauge: 18 – Relay Control: Connect to “Fuel Pump Feed” blunt lead on body harness.

D – FPCM Control Relay

NOTICE

Relay is environmentally sealed. This unit can be mounted anywhere in the vehicle, however it is not recommended to be installed near hot locations such as the exhaust system, on the engine, or high splash areas such as the wheel wells. If routing the wiring harness through the bulkhead or any sheet metal, a grommet is required to prevent damage

E - Fuel Mod Control

2 pin connector; Connect fuel mod control connector to fuel mod control connector on body harness.

Pin	Function	Color	GA
1	PWM CONTROL	BU/LG	20
2	PWM FEEDBACK	BR/RD	20

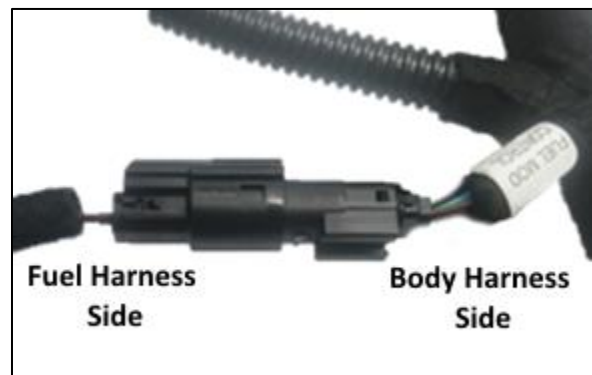
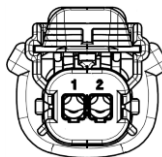

All diagrams are wire insertion view



F & G - Fuel Pump Blunt Leads & Ground

When installing the fuel pump harness, care and consideration should be taken as to location and routing of harness. The fuel pump blunt leads and ground should be kept as short as possible to avoid voltage drop. Voltage decreases over distance in different gauge wires at different rates, this can cause issues in fuel pressure desired as the fuel pump wiring is highly sensitive to voltage changes. Keep voltage drop to a minimum using appropriate gauge wire.

G – Color: BK - Gauge:12 – Fuel Pump Ground: Ground eyelet. Do NOT extend

VT/LB – Gauge: 12 – Pump Return (-)

BU/OG – Gauge: 12 - Pump PWM Control (+)

Bare Shield – Gauge: 20 - Shield cable is to be twisted around the entire length of the fuel pump blunt leads to isolate the fuel pump wires from noise as shown below.



Fuel Pump Control Module (FPCM)

The FPCM is a module which controls the PWM output to the fuel pump to achieve correct fuel pressure at the fuel rail.

NOTICE

FPCM is environmentally sealed. This unit can be mounted anywhere in the vehicle, however it is not recommended to be installed near hot locations such as the exhaust system, on the engine, or high splash areas such as the wheel wells. If routing the wiring harness through the bulkhead or any sheet metal, a grommet is required to prevent damage

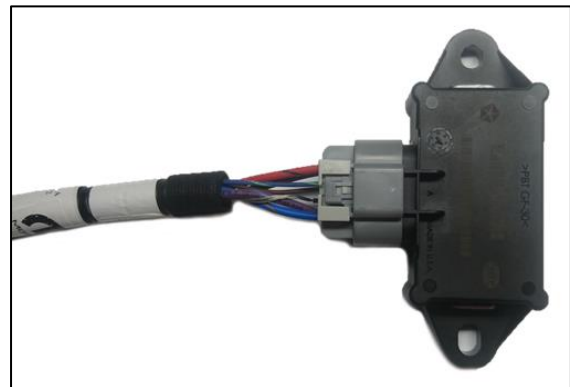

Pin	Function	Color	GA
A	FUEL MODULE FEED	RD/BK	12
B	PWM CONTROL	BU/LG	20
C	NO CONNECT	NA	0
D	PUMP PWM CONTROL	BU/OG	12
E	FUEL MODULE GROUND	BK	12
F	PWM FEEDBACK	BR/RD	20
G	GROUND	BARE	20
H	PUMP RETURN	VT/BU	12

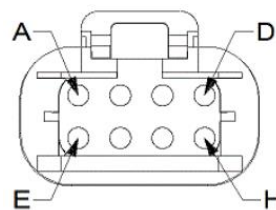

All diagrams are wire insertion view



Body Harness

The body side harness consists of 2 sides, one side to route into the engine bay and mate with the PCM and PDC, and one side to the vehicle cabin for other connections. A grommet hole of 50 mm is needed in the bulkhead to route the harness. Ensure the hole that is cut is on a flat plane of a minimum material thickness to seal of 5 mm and is deburred. Feed the harness through the hole and insert the grommet in place.

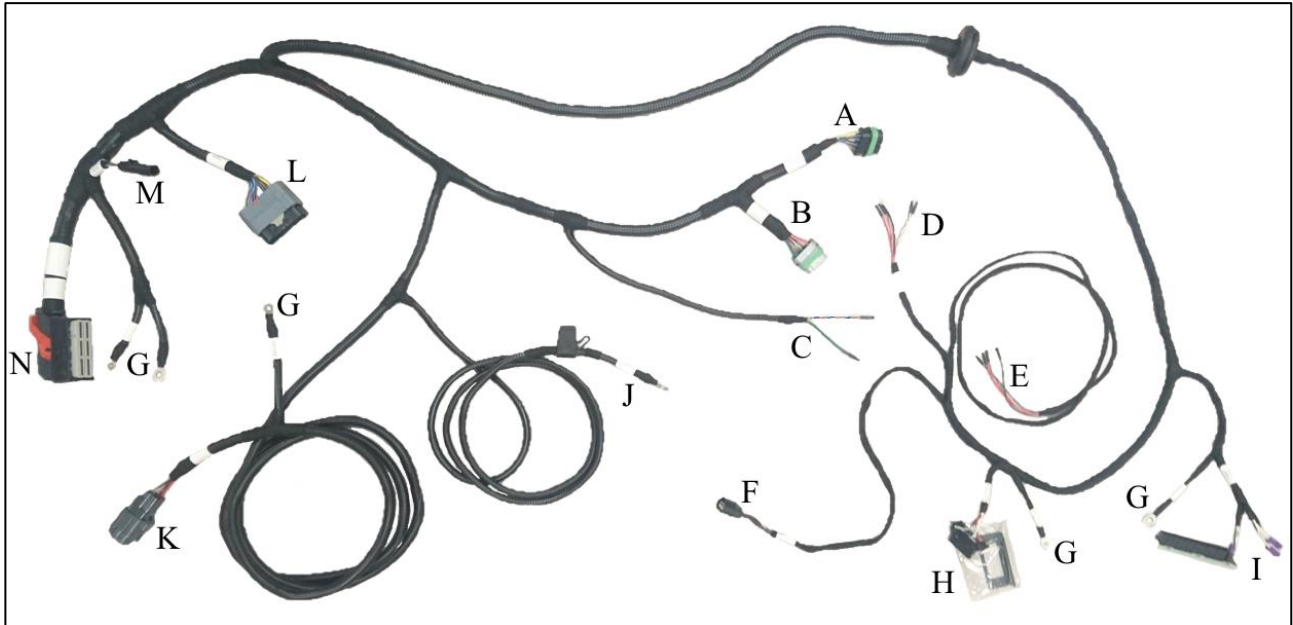

Call Out	Connector
A	PDC A - Black
B	PDC B - Gray
C/D/E	Blunt Leads
F	Pedal
G	Ground
H	DLC & Bracket
I	Star Connectors
J	SC Battery
K	CAC Pump
L	Inline - Body
M	Fuel Mod Control
N	PCM - Body

Blunt Leads

Each blunt end will require the correct corresponding connection on the vehicle.

E – Color: LB/TN – Gauge: 20 – Starter Relay Control: Connect to 12V source provided only when in crank position. Requires a 12V input from ignition switch to control the starter relay only when the ignition is in the crank position.

E – Color: PK – Gauge: 20 – IGN Relay Control: Connect to 12V source provided when in crank and run position. Requires a 12V input from ignition switch to control the ignition relay when the ignition is in the crank and run position.

E – Color: DG/OG – Gauge: 18 – Clutch Interlock: Connect to ground input from clutch pedal switch or neutral safety switch.

E – Color: RED – Gauge: 18 – Aux: Positive output, battery feed, always ON. (12V output, 20A fuse)



C – Color: BU/OG – Gauge: 16 – Fuel Pump Feed: Connect to fuel pump harness “Relay Control” blunt lead. If not using FPCM, this lead can be used as positive output for an electric fuel pump. (12V output, 20A fuse)

C – Color: DG/RD – Gauge: 12 – Cooling Fan Feed: Positive output for an electric cooling fan. (12V output, 30A fuse)

D – All Colors – Gateway: CAN Bus blunt leads

CAN Bus Interface Device (CBID)

The CBID is part number 77072456AB. This part allows the PCM to receive vehicle speed input and to display a Malfunction Indicator Lamp (MIL). The CBID module contains an LED MIL on the component, additionally an external LED MIL can be connected. U1110 & P0501 will be present at first start and remain on until CBID is installed and calibrated. Follow CBID installation sheet.

Blunt Lead	Function	Wire Color	GA
D	EXTERNAL MIL 12V POWER	PK/ BR	18
D	CAN HIGH GATEWAY/STAR CONN	WT/OG	20
D	CAN LOW GATEWAY/STAR CONN	WT/VT	20
D	GATEWAY BATTERY FEED	RED	18
D	GATEWAY GROUND	BK	18

Supercharger Battery

SC Batt – Color: RED – Gauge: 10 – Connect to battery, constant power supply. (40A fuse)

Supercharger CAC Coolant Pump

Supercharger coolant pump 4 pin connector will come pre-capped with plug. Remove this plug and connect the pump if using the 2017 Dodge Challenger supercharger coolant pump listed in the cooling section. If using an aftermarket pump, pin 1 “SC Coolant Pump” can be used as 12V power and pin 2 as ground. Pin 3 “ASD Relay Feed 2” can be used as a relay control for aftermarket pumps, providing 12V only when engine is running. Terminals and seals can be purchased to create a sealed connection from the plug connector.



Pin	Function	Color	GA
1	GROUND	BK	12
2	SC COOLANT PUMP	RD	12
3	ASD RELAY FEED 2	BR/WT	16
4	LIN BUS	WT/TN	18

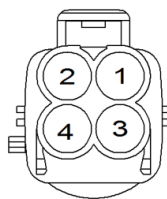

Yazaki part numbers for 12 AWG wire:

Seal: 7158-3083

Terminal: 7114-4142-02

All diagrams are wire insertion view



Fuel Mod Control

2 pin connector located near the PCM connector, connects to the fuel pump harness's fuel mod control connector.

Pin	Function	Color	GA
1	PWM CONTROL	BU/LG	20
2	PWM FEEDBACK	BR/RD	20

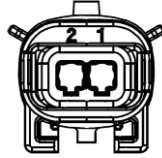

Inline Engine and Body Harness

The inline engine and body harness connector is the only connection between the body harness and the engine harness. Some cavities may be populated with wires, however those wires are not used in this configuration.

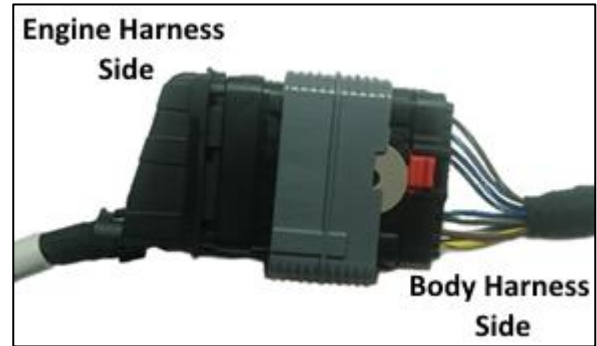

Inline Engine			
Pin	Function	Color	GA
1	STARTER RELAY OUTPUT	YL/GY	14
2	ASD RELAY FEED 1	BR/YL	16
3	FUEL PRESSURE SIGNAL	BR/DB	16
11	SC OUTLET TEMP SIGNAL	VT/BU	18
12	CAC SIGNAL	BR/GN	18
13	ASD CONTROL FEED 2	BR/WT	16
15	BANK 2 TEMP SIGNAL	DB/GN	20
21	EVAP PURGE CONTROL	DB/WT	20
22	BANK 1 TEMP SIGNAL	DB/BU	20

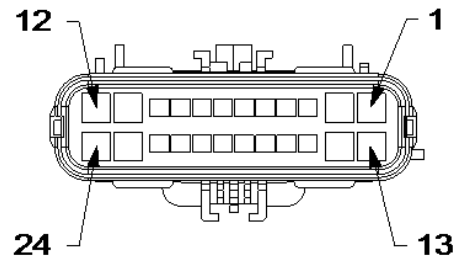

Inline Body			
Pin	Function	Color	GA
1	STARTER RELAY OUTPUT	YL/GY	14
2	ASD RELAY FEED 1	BR	16
3	FUEL PRESSURE SIGNAL	BR/BU	20
11	SC OUTLET TEMP SIGNAL	VT/LB	18
12	CAC SIGNAL	BR/LG	18
13	ASD CONTROL FEED 2	BR/WT	16
15	BANK 2 TEMP SIGNAL	BU/LG	18
21	EVAP PURGE CONTROL	BU/WT	20
22	BANK 1 TEMP SIGNAL	BU/LB	18

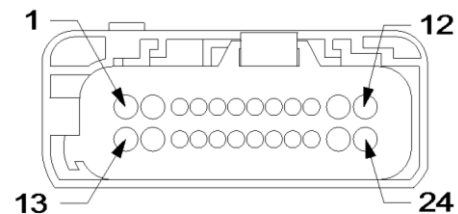

All diagrams are wire insertion view



Power Distribution Center (PDC)

There are 2 connectors that plug into the PDC and 2 battery post terminals. Torque for the PDC feet is a maximum of 2.7 N·m (24 in. lbs.).

NOTICE

The PDC connectors are environmentally sealed. This unit can be mounted anywhere in the vehicle, however it is not recommended to be installed near hot locations such as the exhaust system or high splash areas such as wheel wells.



Pin	Function	Color	GA
PDC 1			
1A	STARTER SOLENOID	YL/GY	14
1B	ASD RELAY CONTROL	BR/YL	20
1C	ASD RELAY FEED 1	BR	16
1D	ASD RELAY FEED 2	BR/WT	16
1E	CLUTCH INTERLOCK	GN/OG	20
1F	STARTER RELAY CONTROL	LB/TN	20
1G	FUEL PUMP REPLAY CONTROL	BU/TN	20
1H	FUEL PUMP FEED	BU/OG	12
PDC 2			
2A	DLC/ECM POWER FEED	RD	16
2B	GATEWAY POWER FEED	RD	18
2C	IGN SWITCH BATTERY FEED	RD	18
2D	ECM RUN/START FEED	PK/BR	18
2E	COOLING FAN FEED	DG/RD	12
2F	COOLING FAN RELAY CONTROL	BR/LB	18
2G	IGN/FUEL PUMP RELAY RETURN	BK/GR	18
2H	IGN RELAY CONTROL	PK	20

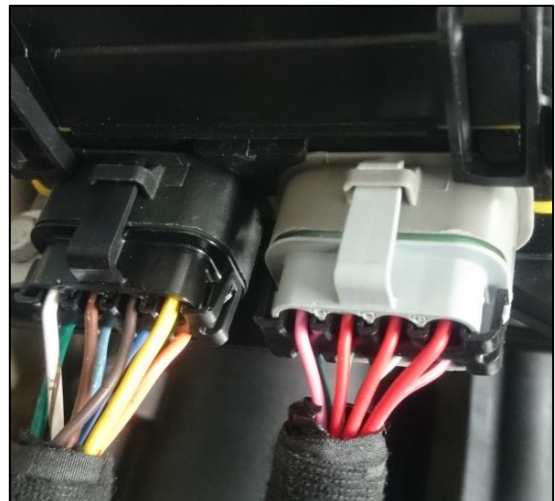
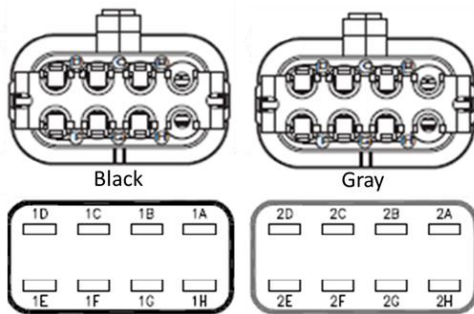
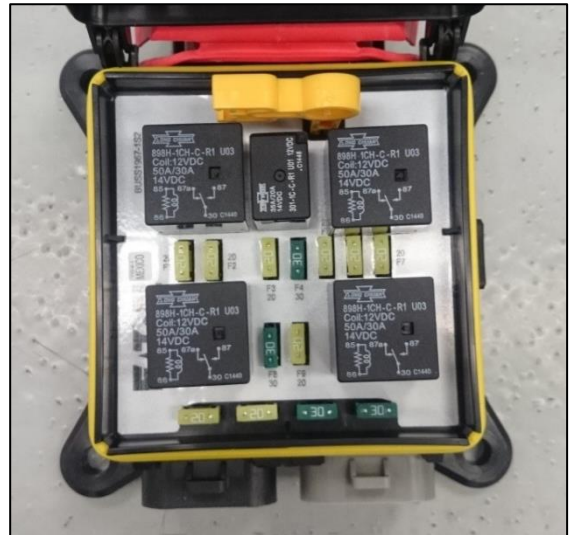

All diagrams are wire insertion view

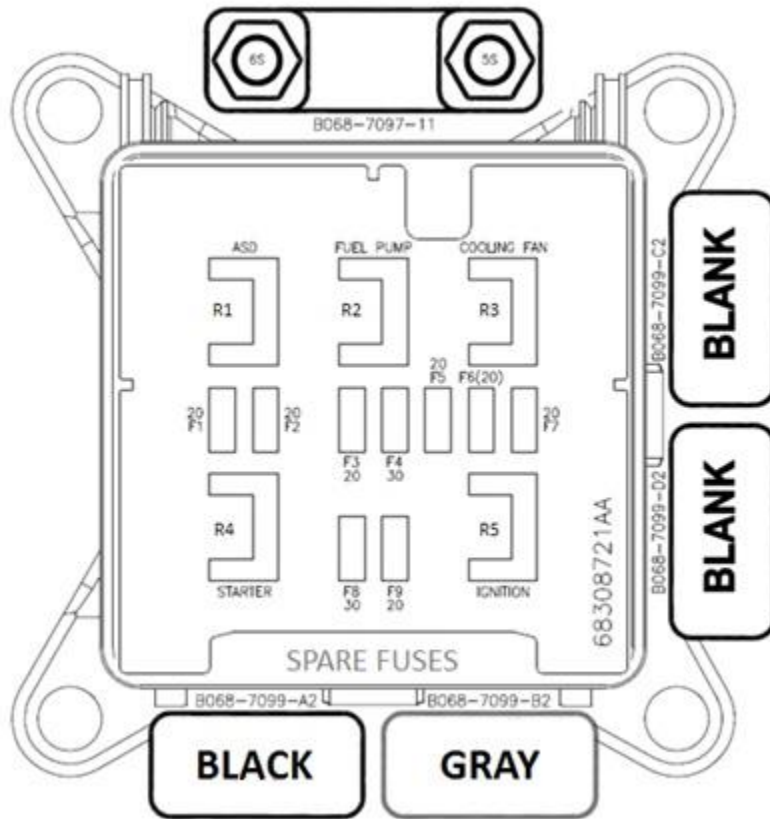

MINI FUSES	
F1	ASD 2 (20A)
F2	ASD 1 (20A)
F3	FUEL PUMP (20A)
F4	COOLING FAN (30A)
F5	AUX (20A)
F6	GATEWAY (20A)
F7	DLC/ECM (20A)
F8	STARTER SOLENOID (30A)
F9	IGNITION RUN/START (20A)
RELAYS	
R1	ASD
R2	FUEL PUMP
R3	COOLING FAN
R4	STARTER
R5	IGNITION

PDC Bus Bar & PDC Battery Connection

The PDC bus bar will already be installed on the PDC. The bus bar connects both PDC power studs together to allow for only one power cable to be connected. Connect the PDC battery terminal to either power stud on the PDC above the bus bar, ensure the eyelet tab is pointing upwards. The power studs' maximum torque is 20.4 N·m (15 ft. lbs.), with a max power rating of 200 amps. Close the terminal flap when complete.



STAR Connector and Connections

The Star connector has multiple inputs; only 3 will be used in this application. Only two star connectors on the chassis harness will come installed to the star connector. Connect Star 3 when using the CAN Bus Interface Device.

Pin	Function	Color	GA
Star 1			
1	CAN +	WT/LG	20
2	CAN -	WT/LB	20
3	GROUND	BK/GY	20
Star 2			
1	CAN +	WT/YL	20
2	CAN -	WT/BK	20
Star 3			
1	CAN +	WT/OR	20
2	CAN -	WT/VT	20

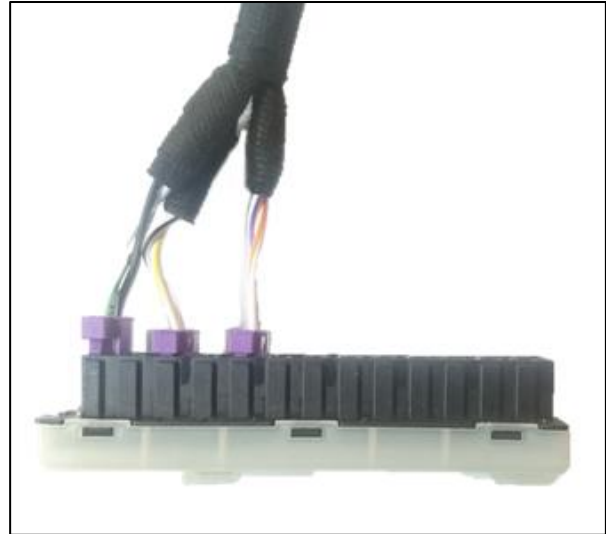
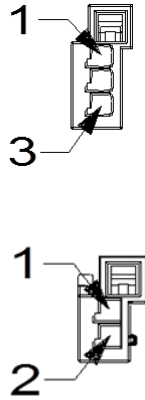

Pedal Connector

⚠ WARNING

To prevent SERIOUS INJURY or DEATH, NEVER modify wiring in the accelerator pedal system.

The accelerator pedal connector is a single 6 pin connector.

Pin	Function	Color	GA
1	APP 5 VOLT 1	BR/VT	20
2	APP SIGNAL 1	BR/WT	20
3	APP SENSOR GROUND 1	BR/YL	20
4	APP SENSOR GROUND 2	BR/RD	20
5	APP SIGNAL 2	WT/BR	20
6	APP 5 VOLT 2	VT/BR	20

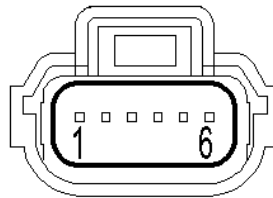

All diagrams are wire insertion view



Data Link Connector (DLC)

This connector is an OBDII plug that should be mounted in the vehicle on the driver’s side to diagnose issues and codes the PCM may be outputting. When reading codes, a P1400 code may be present. This indicates an aftermarket controller is being used. U1110 and P0501 may be present at first start and remain on until CBID is installed and calibrated.

Pin	Function	Color	GA
4	GROUND	BK	20
5	GROUND	BK	20
6	CAN C (+)	WT/LG	22
14	CAN C (-)	WT/LB	22
16	FUSED B (+)	RD	20

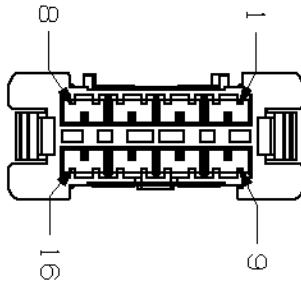

The wiring harness will include a DLC bracket. Install the bracket anywhere in the interior of the vehicle, allowing enough space to access the connector when needed. The connector will clip into the opening of the bracket.

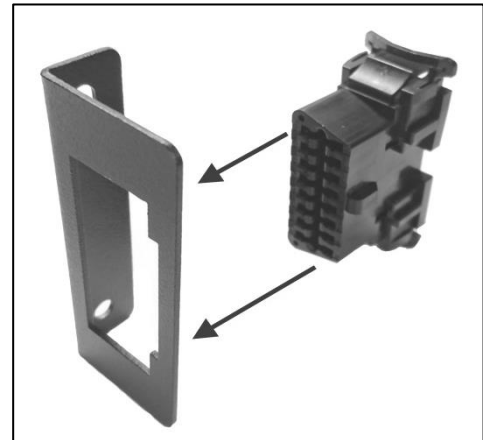

Final Connection

WARNING

To prevent SERIOUS INJURY, DEATH or PROPERTY DAMAGE:

- DO NOT connect battery until all connections are made.

Battery

The battery must supply a minimum of 12.65 volts. Connect battery to PDC battery connection power stud as final step before initiating starting procedures. The power studs’ maximum torque is 20.4 N·m (15 ft. lbs.), with a max power rating of 200A. Close the terminal flap when complete. Battery terminal should not be loose.

All diagrams are wire insertion view



Hellcrate 6.2L Supercharged Crate HEMI® Engine Kit Instruction Sheet

www.mopar.com

PCM Engine Harness			
Pin	Function	Color	GA
2	MAP SNSR SIG 2	VT/YL	18
3	MANIFOLD AIR TEMP	DB/TN	20
4	OIL PRESS SENSE/SW SIG	VT/GY	20
8	FUEL INJECTOR SIG 1	BR/YL	18
9	FUEL INJECTOR SIG 2	BR/DB	18
10	FUEL INJECTOR SIG 3	BR/BU	18
11	FUEL INJECTOR SIG 4	BR/TN	18
12	COOLANT TEMP SNSR SIG	VT/OG	20
13	SNSR KNOCK SIG 2	BR/WT	20
14	SNSR KNOCK SIG 1	DB/YL	20
15	LAMBDA PUMPING CURRENT PIN FEED	BR/GN	18
16	LAMBDA ADJUST PIN SENSE	BR/BU	20
17	LAMBDA PUMPING CURRENT PIN FEED 2	BR/DG	18
18	LAMBDA ADJUST PIN SENSE 2	BR	20
19	O2 1/2 DOWNSTREAM SNSR SIG	DB/YL	20
20	O2 DOWNSTREAM SENSE RTN	DB/DG	20
21	O2 2/2 DOWNSTREAM SNSR SIG	BR	20
22	VARIABLE CAMSHAFT TIMING SIG	DB	20
24	O2 1/1 HEATER PWM	BR/BU	16
32	ALTERNATOR FIELD FEED	BR/GY	18
33	MTR ETC +	TN/YL	18
34	MTR ETC -	TN/OG	18
35	ALTERNATOR SENSE	RD/VT	18
37	SNSR KNOCK RTN 2	WT/BR	20
38	SNSR KNOCK RTN 1	BR/GN	20
39	O2 1/1 UPSTREAM SNSR SIG	DB/BU	20
40	O2 UPSTREAM SENSE RTN	BR/DG	20
41	O2 2/1 UPSTREAM SNSR SIG	DB/GN	20
42	O2 UPSTREAM SENSE RTN 2	GY/DG	20
43	SNSR ENGINE OIL TEMP FOR QUALITY	VT/BR	20
44	INTAKE TEMP SNSR SIG	DB/GN	20
45	MAP SNSR SIG	VT/BR	20
46	SUPERCHARGER BYPASS SIG 1	DB/GY	20
48	O2 1/2 DOWNSTREAM HEATER FEED	BR/WT	16
49	IGNITION COIL DRIVER 3	DB/OG	16
50	IGNITION COIL DRIVER 2	DB/BG	16
51	IGNITION COIL DRIVER 1	DB/DG	16
55	SUPERCHARGER BYPASS VALVE (+)	VT/OG	20
56	SUPERCHARGER BYPASS VALVE (-)	VT/GY	20
57	SUPERCHARGER BYPASS SIG 2	DB/OG	20
58	BOOST PRESS SIG	BR/OG	20
65	THROTTLE POS SNSR RTN	BR/DB	20
66	SENSOR GROUND	DB/DG	20
67	5V ENGINE SNSR FEED PRIM	PK/YL	20
68	SENSOR GROUND	BR/WT	20
71	BOOST PRESS SIG 2	BR/BU	20
72	O2 2/1 HEATER PWM	BR/TN	16
73	IGNITION COIL DRIVER 4	DB/GY	16
74	IGNITION COIL DRIVER 5	DB/YL	16
75	IGNITION COIL DRIVER 6	DB/OG	16
76	IGNITION COIL DRIVER 7	BR	16
77	IGNITION COIL DRIVER 8	DB/YL	16
79	FUEL INJECTOR SIG 5	BR/OG	18
80	FUEL INJECTOR SIG 6	BR/VT	18
81	FUEL INJECTOR SIG 7	BR/YL	18
82	FUEL INJECTOR SIG 8	BR/BU	18
85	CAMSHAFT POSITION SNSR SIG	DB/GY	20
86	CRANKSHAFT SPEED SNSR SIG	BR/BU	20
87	5V ENGINE SNSR FEED SEC	YL/PK	20
88	CRANKSHAFT POSITION SNSR GROUND	DB/GY	20
89	THROTTLE POS SNSR SIG 1	BR/OG	20
90	THROTTLE POS SNSR SIG 2	BR/DG	20
96	O2 2/2 DOWNSTREAM HEATER FEED	BR/GY	16

PCM Body Harness			
Pin	Function	Color	GA
22	FUEL PRESSURE SIGNAL	BR/BU	20
23	ECM RUN / START FEED	PK/BR	18
33	CAN LOW ECM/STAR CONN	WT/BK	20
41	GROUND	BK	18
43	CAC SIGNAL	BR/LG	18
52	ECM GROUND	BK	18
53	ECM GROUND	BK	18
55	LIN BUS	WT/TN	18
57	CANHIGH ECM/STAR CONN	WT/YL	20
58	BANK 1 TEMP SIGNAL	BU/LB	18
59	BANK 2 TEMP SIGNAL	BU/LG	18
60	SC OUTLET TEMP SIGNAL	VT/LB	18
61	PWM FEEDBACK	BR/RD	20
67	PEDAL SENSOR GROUND 2	BR/RD	20
68	PEDAL SENSOR GROUND 1	BR/YL	20
69	PEDAL 5 VOLT 2	VT/BR	20
72	GROUND	BK	18
73	FUEL PUMP RELAY CONTROL	BU/TN	20
74	ASD RELAY FEED 2	BR/WT	16
75	ASD RELAY FEED 2	BR/WT	16
76	ASD RELAY FEED 2	BR/WT	16
78	COOLING FAN RELAY CONTROL	BR/LB	18
80	ASD RELAY CONTROL	BR/YL	20
83	PWM CONTROL	BU/LG	20
87	ECM RUN / START FEED	PK/BR	18
91	PEDAL SIGNAL 2	WT/BR	20
92	PEDAL SIGNAL 1	BR/WT	20
93	PEDAL 5 VOLT 1	BR/VT	20
94	PURGE SOLENOID	BU/WT	20
96	DLC / ECM POWER FEED	RD	16

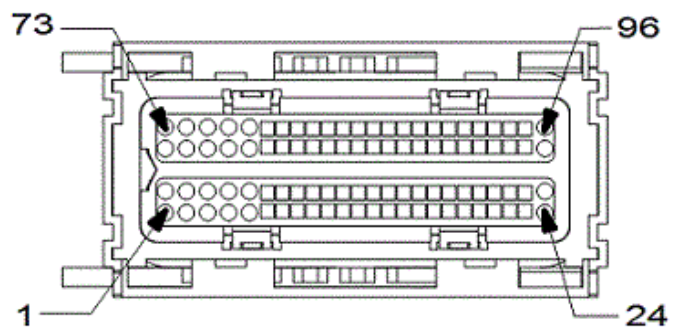

All diagrams are wire insertion view



How to splice and connect blunt ends correctly:

1. Place the strands of the wires overlapping each other inside of the splice clip (1).

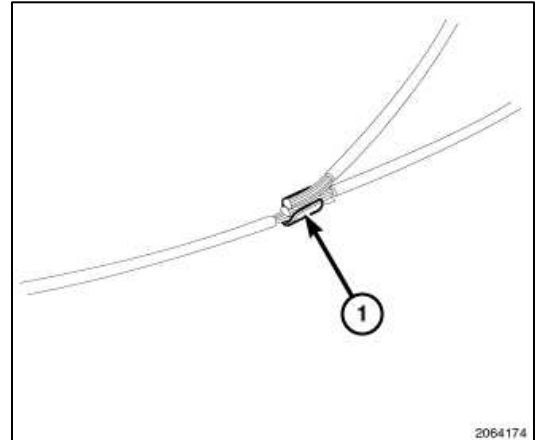

2. Using MOPAR crimping tool (1) or equivalent, crimp the splice clip and wires together.

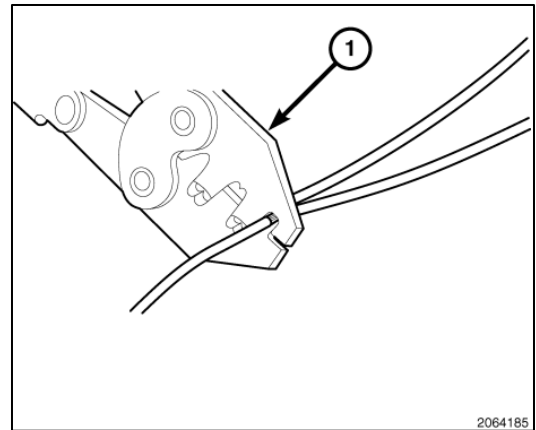

3. Solder (3) the connection (2) together using rosin core solder (1).

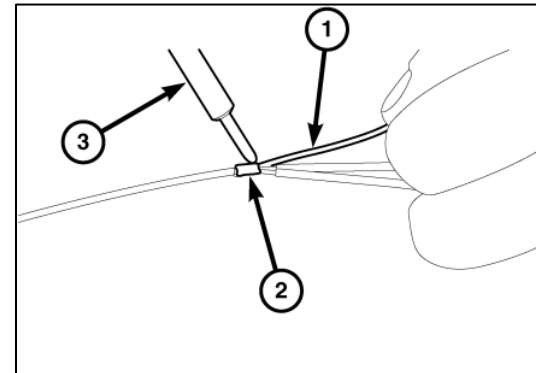

4. Center the heat shrink tubing (2) over the solder joint and heat using a heat gun. Heat the joint until the tubing is tightly sealed and sealant (1) comes out of both ends of the tubing.

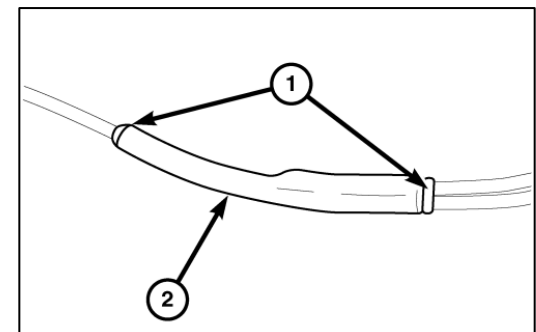



Break-In/Maintenance

Follow this procedure below in the correct order and read all content prior to starting your new crate engine.

Engine Oil

For best performance and maximum protection under all types of operating conditions, the manufacturer only recommends full synthetic engine oils that meet the American Petroleum Institute (API) categories of SN.

The engine oil filler cap also shows the recommended engine oil viscosity for the engine. Use synthetic engine oils provided the recommended oil quality requirements are met, and the recommended maintenance intervals for oil and filter changes are followed. Synthetic engine oils which do not have both the engine oil certification mark and the correct SAE viscosity grade number should not be used. The manufacturer strongly recommends against the addition of any additives (other than leak detection dyes) to the engine oil. Engine oil is an engineered product and its performance may be impaired by supplemental additives.

6.2L	SAE 0W-40, Synthetic API Certified	FCA Material Standard MS-12633	6.6 Liters	7 Quarts
------	------------------------------------	--------------------------------	------------	----------

To assure proper engine lubrication, the engine oil must be maintained at the correct level. The recommended oil quantity may differ from vehicle to vehicle depending on oil cooling location and size, ensure oil level is in the “SAFE” range and adjust if needed. Check the oil level at regular intervals, such as once a month. The best time to check the engine oil level is about five minutes after a fully warmed engine is shut off. Checking the oil while the vehicle is on level ground will improve the accuracy of the oil level readings. Maintain the oil level in the “SAFE” range. Adding 1.0 quart (.95 liters) of oil when the reading is at the bottom of the “SAFE” range will result in an oil level at the top of the “SAFE” range on these engines.

NOTICE

- Overfilling or underfilling will cause oil aeration or loss of oil pressure. This could damage your engine.
- Under no circumstances should oil change intervals exceed 6,000 miles (10,000 km) or six months, whichever occurs first.
- Do not use chemical flushes in your engine oil as the chemicals can damage your engine

Coolant

Use only MOPAR Antifreeze/Engine Coolant (OAT coolant conforming to MS.90032) 10 Year/150,000 Mile Formula or equivalent in the engine’s cooling systems.

NOTICE

- Mixing of engine coolant (antifreeze) other than specified Organic Additive Technology (OAT) engine coolant (antifreeze) may result in engine damage and may decrease corrosion protection. OAT engine coolant is different and should not be mixed with Hybrid Organic Additive Technology (HOAT) engine coolant (antifreeze) or any “globally compatible” coolant (antifreeze). If a non-OAT engine coolant (antifreeze) is introduced into the cooling system in an



emergency, the cooling system will need to be drained, flushed, and refilled with fresh OAT coolant (conforming to MS.90032) by an authorized dealer as soon as possible.

- Do not use water alone or alcohol-based engine coolant (antifreeze) products. Do not use additional rust inhibitors or antirust products, as they may not be compatible with the engine coolant.
- This engine has not been designed for use with propylene glycol-based engine coolant (antifreeze). Use of propylene glycol-based engine coolant (antifreeze) is not recommended.

Pedal Learn

Visit a MOPAR dealer to perform the learn functions below:

1. Connect a battery charger to the vehicle.
2. Cycle ignition to RUN.
3. Connect the scan tool (wiTECH 2.0).
4. Enter VIN as "1111111111111111".
5. Select "2015" and "LA" (Challenger) as vehicle from drop down menus.
6. Select "PCM."
7. Select "Misc Functions."
8. Select "Learn ETC" and follow on-screen instructions.
9. Cycle ignition key after the successful routine completion.
10. Select "Misc Functions."
11. Select "Cam/Crank Relearn" and follow on-screen instructions.
12. Cycle ignition key after the successful routine completion.

Oil Prime

Ensure proper lubrication within the head of the engine and throughout the valve train. This can be done by removing the head covers. Prior to starting the engine, prime the oil system using a pre-lube engine oiler tank. Fill oil filter with oil and install, then remove oil pressure switch and fit the correct adapter for your pre-lube engine oiler. Ensure there is oil pressure prior to turning engine over. Check oil level and for oil leaks from filter, oil coolers, oil filter adapters and fittings.

Fuel Prime

Turn ignition key to "ON" position and leave it on the on position for 3-5 seconds, listen for fuel pump priming. Turn ignition key to "OFF" position and wait approximately 3 seconds. Repeat this process 5 times. The fuel system should be pressurized now.

⚠ WARNING

To prevent SERIOUS INJURY, DEATH or PROPERTY DAMAGE:

Before starting the engine:

- Ensure transmission is in the neutral position
- Secure vehicle with the parking brake or wheel chuck



Start & Check

Once all other procedures above are complete turn engine over using the ignition. Turn the ignition to “ON” position, listen for fuel pump priming, turn the ignition to “start” position and hold until the motor starts or for 5 seconds maximum. Return the ignition to “ON” position and repeat a maximum of 5 times to start engine. Once engine has started, listen for unusual noises such as engine knock or engine misfires. FEAD drive belts may be noisy at first if tension is not correct or engine is very cold.

Warm Up

Once started the engine will be cold and will idle at a high RPM. Do not depress the accelerator during warm-up stage. The RPM should decrease gradually as temperature increases. The idle RPM will level out and the engine should be running at approximately 200–230°F (93–110°C). Once the engine has reached operating temperature, follow break-in procedure below.

Break-In

The following tips will be helpful in obtaining optimum performance and maximum durability for your new crate engine.

Despite modern technology and World Class manufacturing methods, the moving parts of the engine must still wear in with each other. This wearing in occurs mainly during the first 500 miles (805 km) and continues through the first oil change interval. It is recommended for the operator to observe the following driving behaviors during the new engine break-in period:

0 to 100 miles (0 to 161 km):

- Do not allow the engine to operate at idle for an extended period of time.
- Depress the accelerator pedal slowly and not more than halfway to avoid rapid acceleration.
- Drive with the engine speed less than 3,500 RPM.

100 to 300 miles (161 to 483 km):

- Depress the accelerator pedal slowly and not more than halfway to avoid rapid acceleration in lower gears (1st to 3rd gears).
- Drive with the engine speed less than 5,000 RPM.

300 to 500 miles (483 to 805 km):

- Exercise the full engine rpm range, shifting manually at higher rpms when possible.
- Do not perform sustained operation with the accelerator pedal at wide open throttle.

500 to 1000 miles (805 to 1610 km):

- Exercise the full engine rpm range, shifting manually at higher rpms when possible.
- Do not perform sustained operation with the accelerator pedal at wide open throttle.



For the first 1500 miles (2414 km):

- Do not participate in track events, sport driving schools, or similar activities during the first 1500 mi (2414 km).

NOTE: Check engine oil with every refueling and add if necessary. Oil and fuel consumption may be higher through the first oil change interval. Running the engine with an oil level below the add mark can cause severe engine damage.

Oil Change

The engine oil filter should be replaced with a new filter at every engine oil change. This engine has a full-flow type oil filter. Use a filter of this type for replacement. The quality of replacement filters varies considerably. Only high quality filters should be used to assure most efficient service. MOPAR engine oil filters are a high quality oil filter and are recommended.

Care should be taken in disposing of used engine oil and oil filters from your vehicle. Used oil and oil filters, indiscriminately discarded, can present a problem to the environment. Contact your authorized dealer, service station or governmental agency for advice on how and where used oil and oil filters can be safely discarded in your area.

Maintenance/Service Schedule

To ensure proper operation of your crate engine, follow the maintenance interval schedule below. Follow maintenance instructions at the mileage intervals below or time intervals in months, whichever comes first.

Maintenance Intervals	Miles	Or Kilometers	Or Months
Change the engine oil and engine oil filter.	6,000	10,000	6
If using your vehicle for any of the following: dusty or off-road conditions. Clean if necessary.	12,000	20,000	12
Inspect the exhaust system.	12,000	20,000	12
Clean the engine air cleaner filter.	30,000	50,000	30
Inspect and replace the PCV valve if necessary.	90,000	150,000	90
Replace the spark plugs – 6.2L engine	90,000	150,000	N/A
Flush and replace the engine coolant.	150,000	240,000	120



Troubleshooting

Engine does not crank

1. Battery is dead.
2. Clutch interlock switch not properly connected/faulty.
3. Starter not properly connected.
4. Ignition wiring not properly connected.
5. Blown fuse in PDC.
6. Starter does not engage flywheel correctly.
7. Starter is faulty.

Engine Cranks but does Not Start

1. Powertrain fuses open, inspect all fuses, if an open fuse(s) is found, check the related circuit(s) for a short to ground or high resistance, repair issue and replace fuse.
2. Fuel pump delivery; verify that the fuel tank is not empty before continuing. Check fuel delivery system.
3. Check ignition spark.
4. Possible mechanical Issue, engine exhaust system must be free of any restrictions or leaks, engine valve timing must be within specifications, and check for broken timing components, engine compression must be within specifications.

Engine Cranks but runs poorly

1. Disconnected sensor or solenoid.
2. Wrong fuel injector location.
3. Wrong ignition coil location.
4. Inadequate fuel flow.
5. Connect to the DLC port and diagnose issue.

Other

Please reference the 2017 Dodge Challenger SRT Hellcat service manuals to diagnose other issues. Call MOPAR for assistance if you have any questions regarding the instructions. 1-888-528-HEMI (4364) French and Spanish Instructions available, please call MOPAR.



SHARE YOUR EXPERIENCE WITH MOPAR!

MOPAR would love to hear your thoughts and experiences! Send us a message on our Facebook page or email us at FCAsocial@fcagroup.com with the subject "Crate Engine".