

GFB F150 VTA

Installation Instructions

Part # T9464



+61 2 9534 0099

sales@gfb.com.au

www.gfb.com.au

facebook.com/GFBturbo

instagram.com/gofastbits

GFB
GO FAST BITS

TURBO MANAGEMENT SYSTEMS



PERFORMANCE WITHOUT COMPROMISE

Installation

The GFB VTA part # T9464 is designed for use on 2013-2014 and 2015-on F150 models with the 2.7 and 3.5 EcoBoost engines. The supplied mounting bracket uses the factory diverter valve mounting points on both year ranges, meaning it will also fit any aftermarket intercooler designed to work with the factory diverter valve.

Note that installation requires the vehicle to be raised on ramps, axle supports, or a hoist. **NEVER work under a vehicle supported only with a jack.**

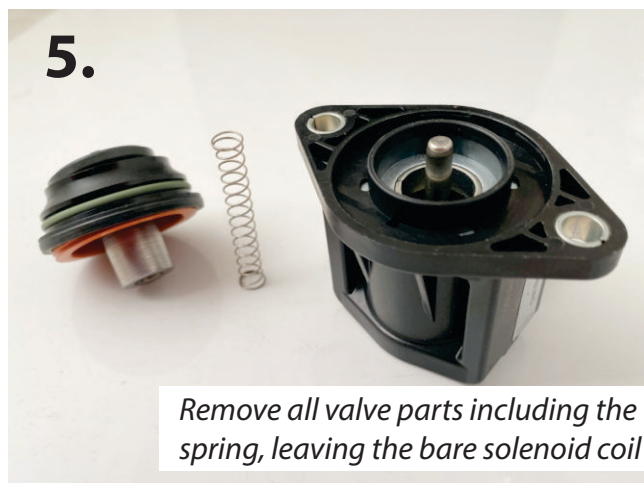
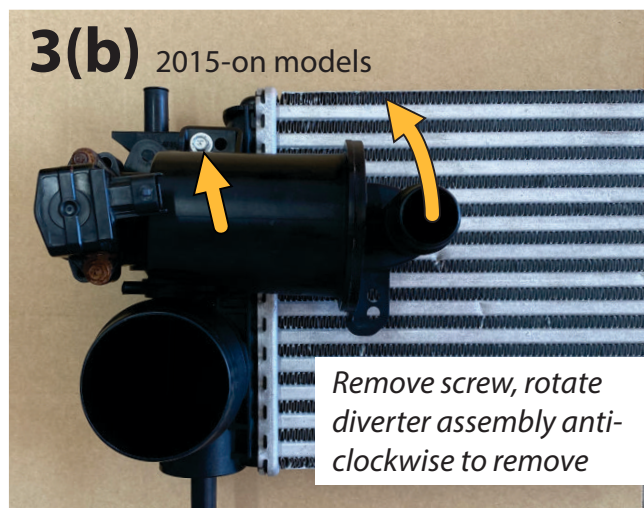
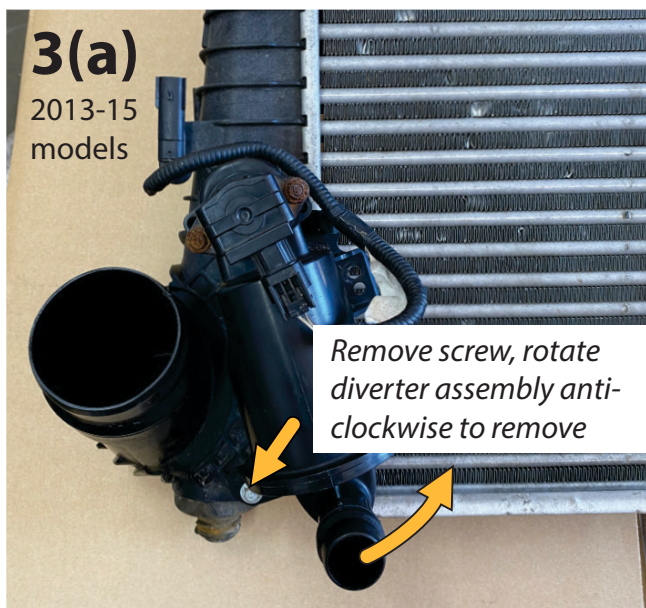
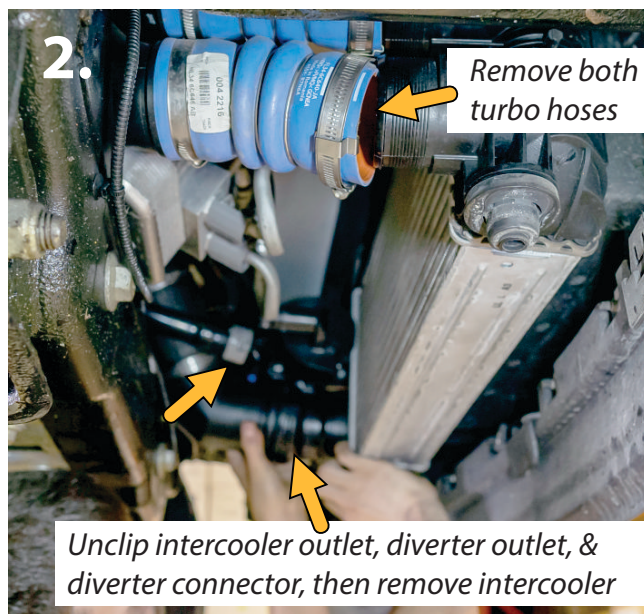
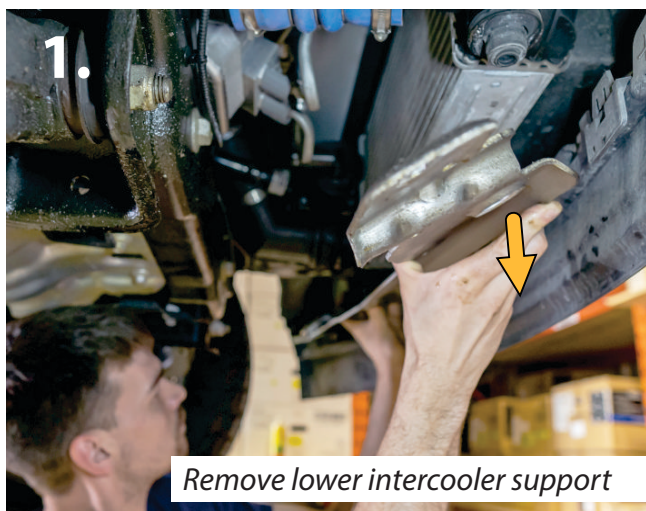

Installation - Continued

- 6.** Assemble the VTA kit as shown below. **PLEASE NOTE:** the solenoid and bracket mounting holes are asymmetrical so these parts cannot be installed backwards. Ensure correct hole alignment before attempting to insert the screws.

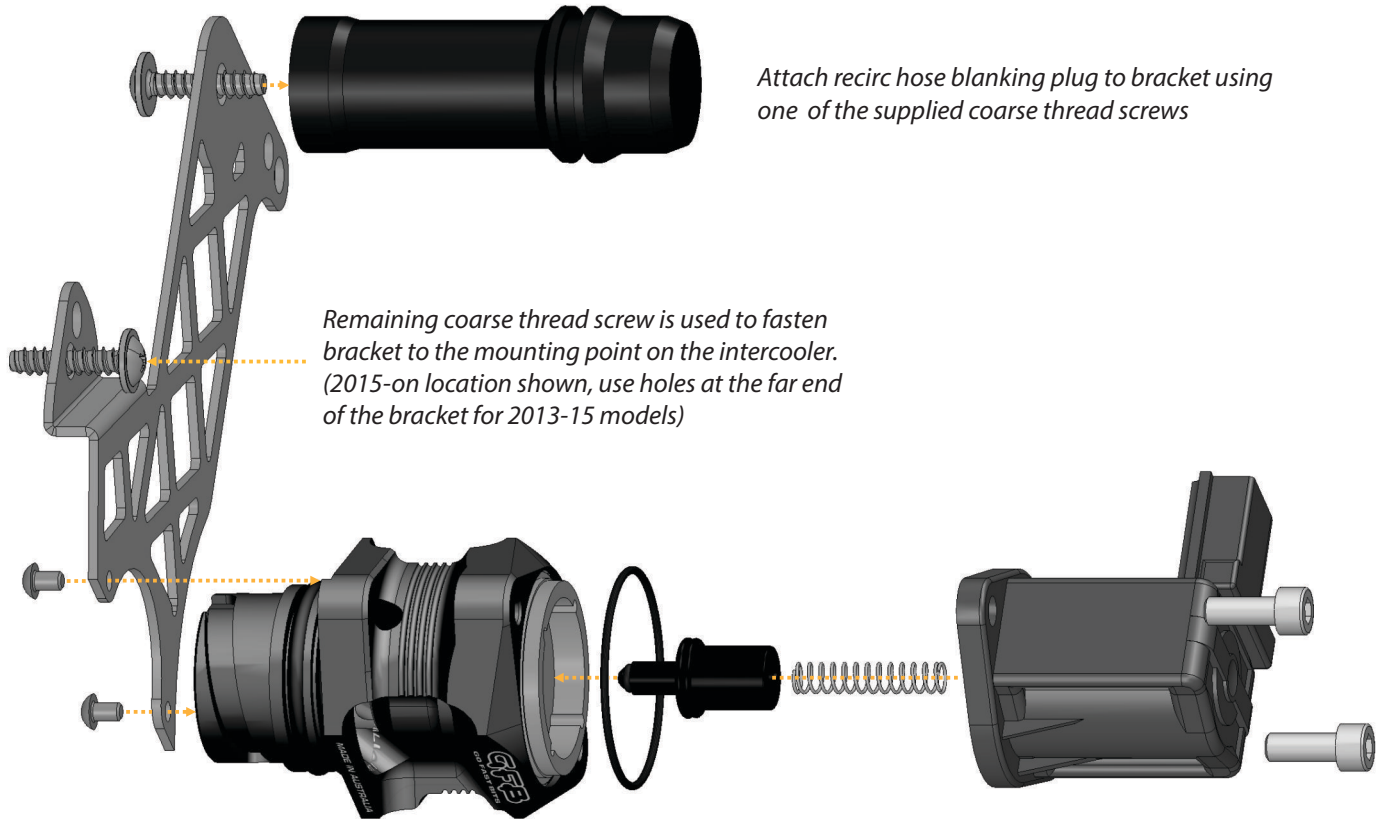

Attach recirc hose blanking plug to bracket using one of the supplied coarse thread screws

Remaining coarse thread screw is used to fasten bracket to the mounting point on the intercooler. (2015-on location shown, use holes at the far end of the bracket for 2013-15 models)

Screw bracket to VTA body using supplied M4x6 screws. Loctite or similar threadlocker is recommended

Assemble factory solenoid onto VTA body with supplied o-ring, plunger, spring, and screws

- 7.** Once the assembly is complete, install the VTA onto the intercooler by twisting it clockwise into the fitting until one pair of holes on the bracket line up with the matching holes on the intercooler. Secure with the supplied coarse thread screw.

- 8.** Re-install the intercooler in the reverse order of removal, then clip the recirculation hose onto the VTA's blanking plug.

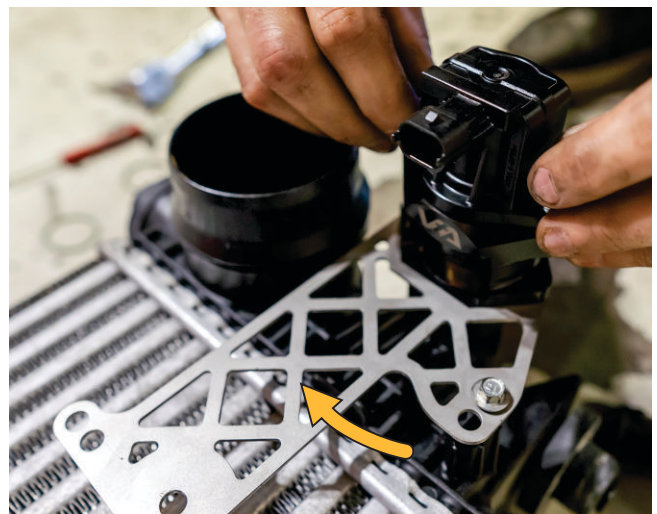

- 9.** Route the wiring loom in a way that ensures it isn't situated in the path of the vented air from the VTA, and is safe from abrasion, then plug the connector back into the solenoid.

- 10.** Re-install the intercooler lower support, then perform a final check to ensure all hoses are secure. The installation is now complete.

Notes on VTA Operation

Oily Residue: It is normal to find some oil around the atmosphere outlet, which is from the oil vapour recirculated through the turbo intake by the PCV system. This does not indicate a faulty valve and is nothing to be concerned about.

Venting Duration/Timing: You might hear the VTA vent at seemingly odd times, but this is determined by the ECU and is not a fault with the VTA.

The ECU will trigger the VTA to vent any time the throttle is closing faster than a specific rate. Even a slight throttle closure can trigger the valve, as long as the rate of closure meets the ECU's requirements. This can also happen during acceleration if traction control activates, as the ECU closes the throttle and opens the diverter even if the gas pedal remains floored.

The difference with the VTA compared to the stock diverter (or a stock diverter fitted to a BOV spacer) is that it needs both the signal from the ECU **and** boost pressure to open - the more boost is present when the ECU triggers, the more the VTA opens. Compared to the factory valve (which opens fully when triggered regardless of boost pressure), the VTA's operating method helps to improve throttle response and also cuts down on the amount of unnecessary venting during light throttle modulation.

Venting Sound: The VTA should vent with a loud "whoosh" sound when lifting off the throttle after acceleration. If a loud fluttering sound is heard instead of a "whoosh", this is an indication that the valve is not venting correctly, in which case the installation should be checked over, in particular the solenoid connector.

Dirty Operating Environment: The VTA is extremely rugged and is constructed with materials that will resist damage and corrosion, and typical environmental debris. However, if the vehicle is to be operated off-road, or in extremely dirty, wet, or corrosive environments, extra safeguards may be necessary (such as shielding or filtering) to protect the VTA.

WARNING: GFB recommends that only qualified motor engineers fit this product. This product is intended for racing use only, and it is the owner's responsibility to be aware of the legalities of fitting this product in his or her state/territory regarding noise, emissions and vehicle modifications. GFB products are engineered for best performance, however incorrect use or modification of factory systems may cause damage to or reduce the longevity of the engine/drive-train components.

GFB Limited Lifetime Warranty:

We live in a throw-away society, conditioned by cheap products and built-in obsolescence to expect eventual failure and discard something when it stops working or is superseded. However, pride in workmanship and our commitment to quality means that when we put our name to something, we are also staking our reputation on it.

That is why we back our products with the best Warranty in the business! You should expect a lifetime of use from a well-engineered product, so if your GFB product fails as a result of defective materials or faulty workmanship whilst you remain the original owner, we will repair or replace it (limited only to the repair or replacement of GFB products provided they are used as intended and in accordance with all appropriate warnings and limitations. No other warranty is expressed or implied).

If a fault occurs as a result of usage outside of the terms of the warranty, or you are not the original owner, fear not, we can still help you. You should never need to throw a GFB product away, as spare parts are available and won't cost the earth.