



DELTA FORCE

COLD AIR INTAKES
BY FLOWMASTER

Installation Instructions for: SYSTEM # 615165

2017-2018 CHEVROLET COLORADO & GMC CANYON with 3.6L Engine

NOT LEGAL FOR SALE OR USE ON ANY POLLUTION-CONTROLLED MOTOR VEHICLE IN CALIFORNIA OR IN STATES THAT HAVE ADOPTED CALIFORNIA EMISSION PROCEDURES.



Watch our
installation video
on YouTube

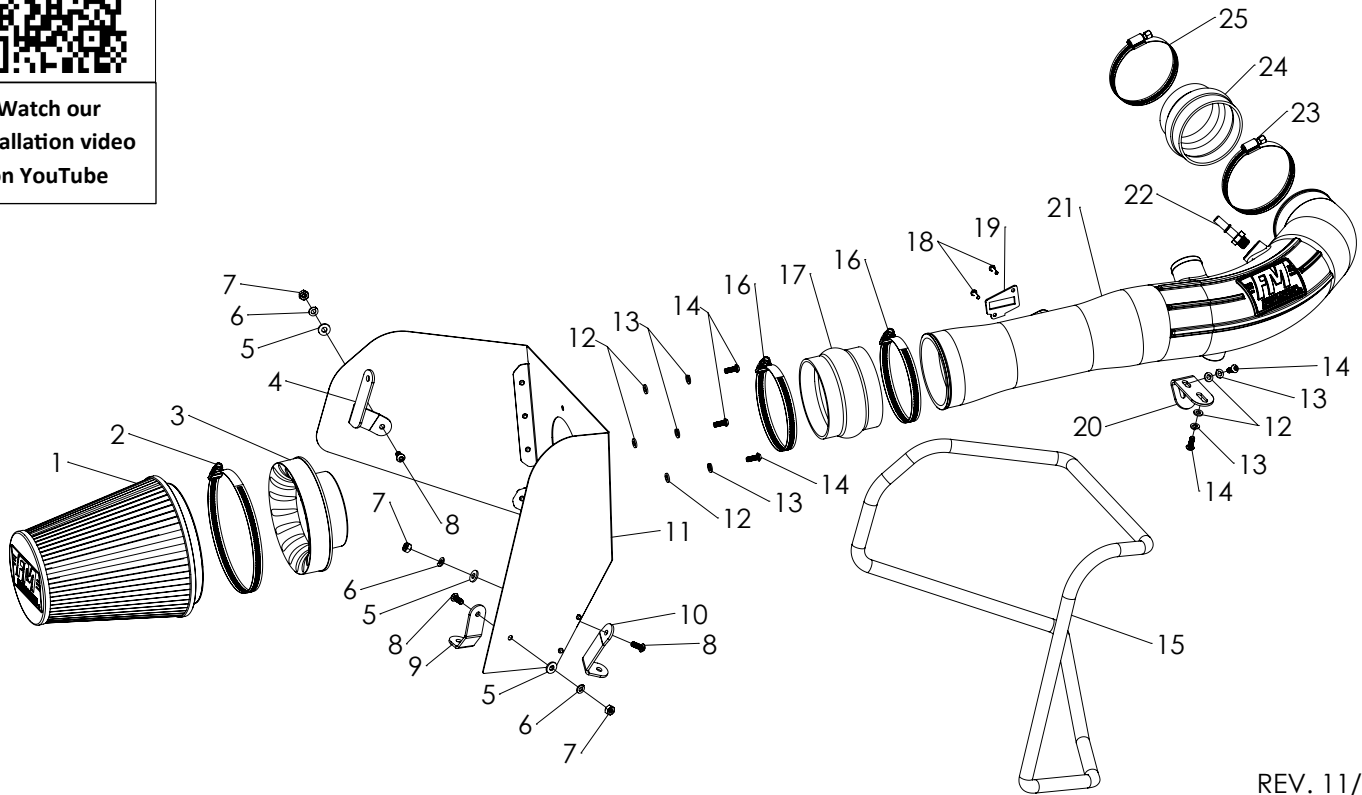

REV. 11/7/17

ITEM NO.	PART NUMBER	DESCRIPTION	QTY.
1	AF1001	AIR FILTER, 8-5/8" x 6" DIA	1
2	MC650H	SCREW CLAMP, #104 (4-1/8" - 7")	1
3	AF6002	ADAPTER, AIR FILTER 4" x 6"	1
4	AF5052	BRACKET 1, 17-18, CANYON-COLORADO, 3.6L	1
5	HW320	FLAT WASHER, 1/4"	3
6	HW322	LOCK WASHER, 1/4"	3
7	HW115	NUT, 1/4"-20	3
8	HW245	SCREW, 1/4"-20 x 5/8"	3
9	AF5054	BRACKET 3, 17-18, CANYON-COLORADO, 3.6L	1
10	AF5053	BRACKET 2, 17-18, CANYON-COLORADO, 3.6L	1
11	AF3047	HEAT SHIELD, 17-18 CANYON-COLORADO, 3.6L	1
12	HW319	FLAT WASHER, M6	5
13	HW318	LOCK WASHER, M6	5

ITEM NO.	PART NUMBER	DESCRIPTION	QTY.
14	HW244	SCREW, M6 x 1.0 x 16MM	5
15	49000061	GASKET, HEAT SHIELD	84"
16	MC400H	SCREW CLAMP, #64 (3-9/16" - 4-1/2")	2
17	AF4005	COUPLER, FLEX 4" I.D. x 3" L	1
18	HW259	SCREW, M4 x 0.7 x 16MM	2
19	GA139	GASKET, MAF SENSOR	1
20	AF5071	BRACKET 4, 17-18, CANYON-COLORADO, 3.6L	1
21	AF2047	INTAKE TUBE, 17-18 CANYON-COLORADO, 3.6L	1
22	AF4060	FITTING, STRAIGHT 25/64" QUICK CONNECT TO 1/4" NPT MALE	1
23	MC350H	SCREW CLAMP, #56 (3-1/16" - 4")	1
24	AF4057	COUPLER, FLEX 3-1/2" I.D. - 3" I.D. x 2-1/2" L	1
25	MC314H	SCREW CLAMP, #52 (2-13/16" - 3-3/4")	1

REVIEW THE INSTRUCTIONS AND VERIFY THE KIT CONTENTS:

1. Please take a moment to read and understand these instructions before installing your Flowmaster cold air intake kit.



2. Use the exploded drawing and parts list (front page) to verify your kit's contents.

In the unlikely event that any parts are missing, please contact Flowmaster Technical Support for replacements.

To simplify assembly and avoid cross-threading fasteners, identify and separate the 1/4-20 screws (item 8) (used with nuts (7)), and the M6 screws (14) (used with filter adapter (3) and intake tube (21)).

REMOVE THE FACTORY AIR INTAKE SYSTEM:

NOTES

- We highly recommend that you retain all factory air intake system parts.
- Please refer to vehicle manufacturer's recommendations regarding removal of factory components.
- Disconnecting the negative battery cable erases pre-programmed electronic memories. Write down all memory settings before disconnecting the negative battery cable. Some radios will require an anti-theft code to be entered after the battery is reconnected. The anti-theft code is typically supplied with your owner's manual. In the event your vehicle's anti-theft code cannot be recovered, contact an authorized dealership to obtain your vehicle's anti-theft code.

3. Turn off the vehicle's ignition and disconnect the negative battery cable.

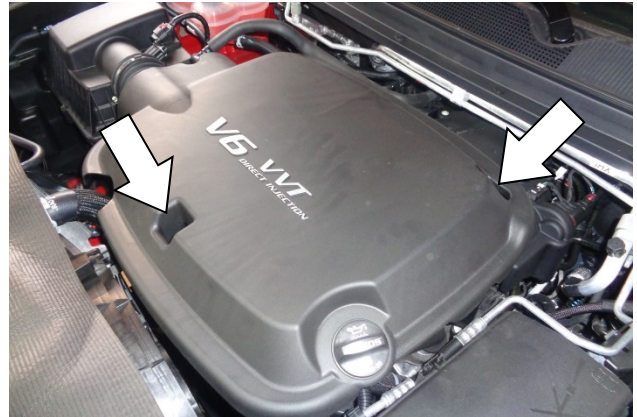

4. **Note:** The engine cover and intake duct are one piece. Remove two (of three) engine cover screws, located in the recesses as shown.

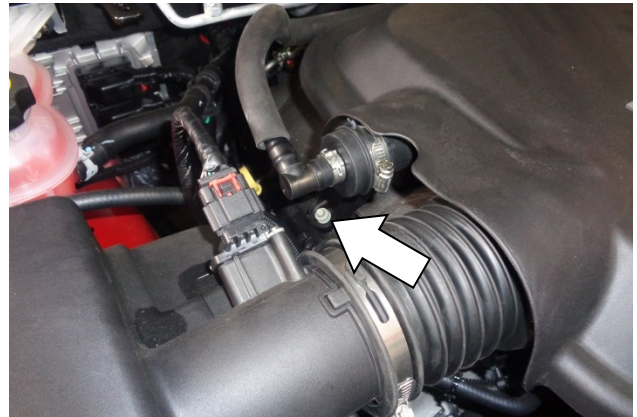

5. Remove the third engine cover screw, located on the passenger side of the cover, just below the breather elbow.

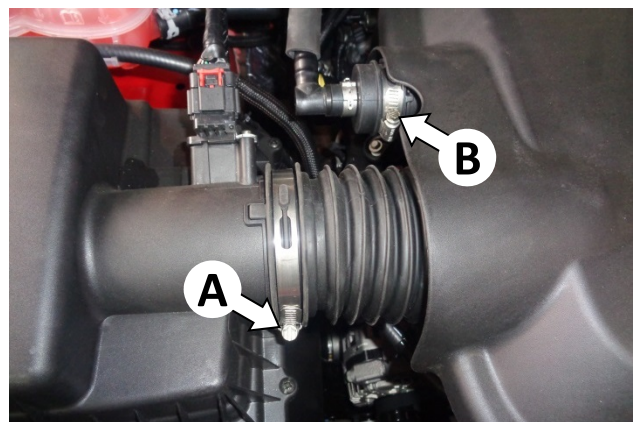

6. Loosen screw clamp (A) and separate the intake duct from the airbox. Then loosen screw clamp (B) and separate the breather from the intake duct.

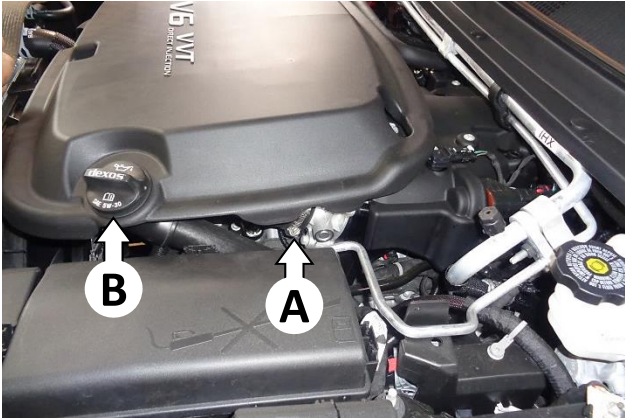

7. Loosen screw clamp (A) at the intake duct and throttle body. Then remove the oil filler cap (B).



8. Carefully lift the engine cover and separate the intake duct from the throttle body. Then at the front of the cover, depress the latch and pull the PCV line straight off the intake duct.



9. Remove the combined engine cover-intake duct from the vehicle.

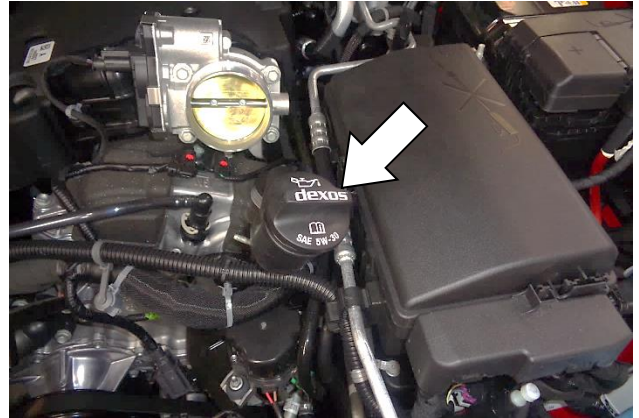

10. Reinstall the oil filler cap.

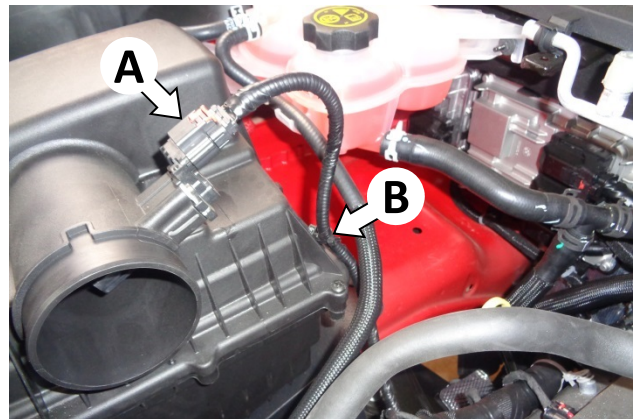

11. Disconnect the mass airflow (MAF) sensor plug (A) by pulling the locking tab away from the sensor, depressing the wide sides of the plug, and pulling it straight off the sensor. Then unclip the wire loom from the airbox (B).

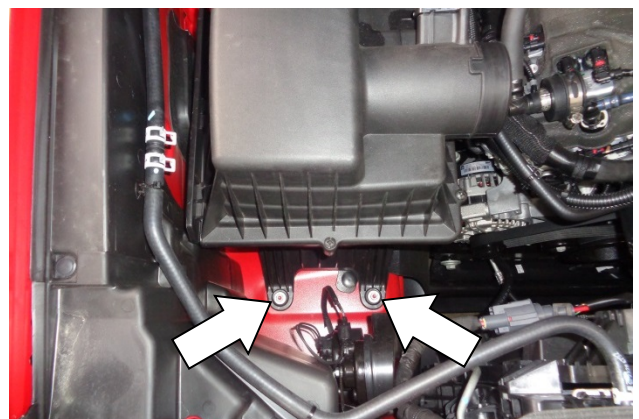

12. Remove the two airbox mount nuts and retain them for reinstallation at Step 21.



13. Firmly lift the airbox straight up and remove it from the vehicle.

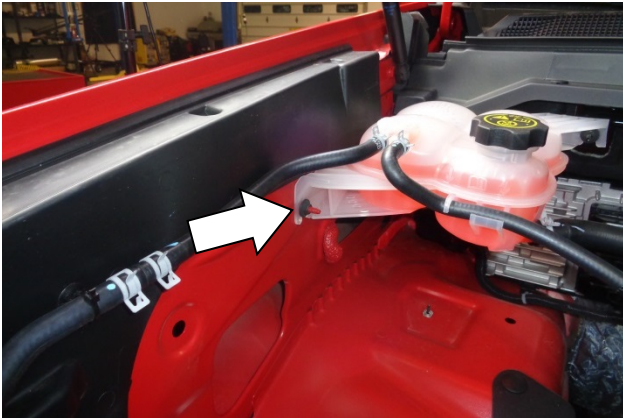

14. Remove the forward mount nut from the coolant overflow reservoir and **retain it for reinstallation at Step 22.**



15. Remove the MAF sensor from the airbox, then remove the factory gasket from the sensor. **CAUTION: The sensor is delicate!** Handle it with care, and store it in a safe location until reinstallation.

ASSEMBLE AND INSTALL YOUR FLOWMASTER COLD AIR INTAKE SYSTEM:

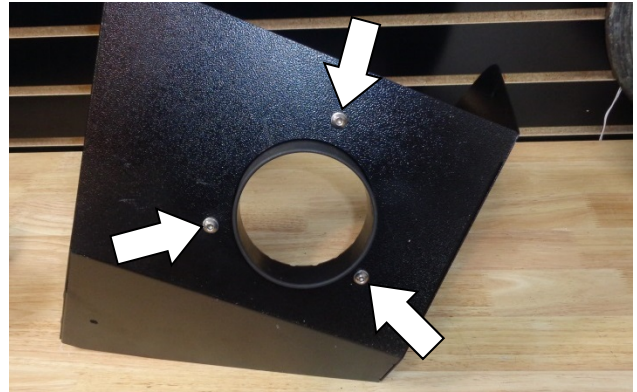

16. Attach the air filter adapter (3) to the heat shield (11) using the M6 screws (14), lock washers (13) and flat washers (12).

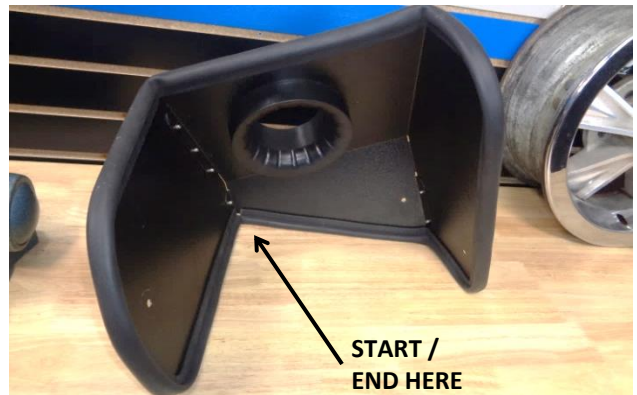

17. Attach the gasket (15) to the heat shield. Starting at the corner shown, firmly press the gasket onto the edge, gradually working around the heat shield. When you return to the starting point, trim the gasket to fit using metal-cutting shears.



18. Attach bracket (4) to the heat shield using a 1/4-20 screw (8) (on the heat shield side), and a flat washer (5), lock washer (6) and nut (7) (on the bracket side). **Do not fully tighten the fasteners at this time.**



19. Attach bracket (9) to the heat shield using a ¼-20 screw (8) (on the bracket side), and a flat washer (5), lock washer (6) and nut (7) (on the heat shield side). **Do not tighten the fasteners at this time.**



20. Attach bracket (10) to the heat shield using a ¼-20 screw (8) (on the bracket side), and a flat washer (5), lock washer (6) and nut (7) (on the heat shield side). **Do not tighten the fasteners at this time.**

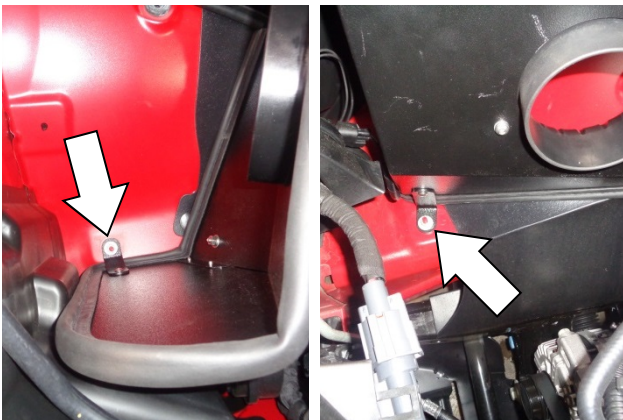

21. Install the assembled heat shield in the vehicle, placing its brackets over the three mount studs. Install and tighten the **front two stock nuts removed at Step 12.**



22. Install and tighten the **nut removed at Step 14.** Then tighten the fasteners holding each bracket to the heat shield.



23. Apply 2 wraps of nylon thread tape to the 25/64" quick-connect fitting (22), and install it in the intake tube (21).



24. Install the MAF sensor gasket (19) on the sensor, ensuring correct orientation. Then install the sensor in the intake tube, using M4 screws (18).



25. Install the two larger screw clamps (16) on the 4" coupler (17), and install the coupler on the filter-end of the intake tube. Do not tighten the clamps at this time.



26. Install the small screw clamp (25) and large screw clamp (23) on the appropriate ends of the reducing coupler (24). Install the large end of the coupler on the throttle body end of the tube. Snug (but do not yet tighten) just the clamp on the tube.



27. Attach bracket (20) to the front engine cover bracket using an M6 screw (14), lock washer (13) and flat washer (12).



28. Re-align the vehicle's PCV fitting as follows:

- a. At the tee fitting in the PCV hard lines, rotate the branch leg of the tee up and back approximately 90 degrees.

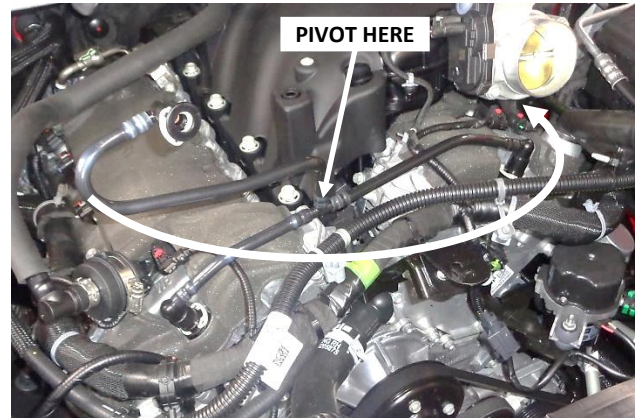

- b. Then rotate the PCV fitting line approximately 180 degrees counter-clockwise.

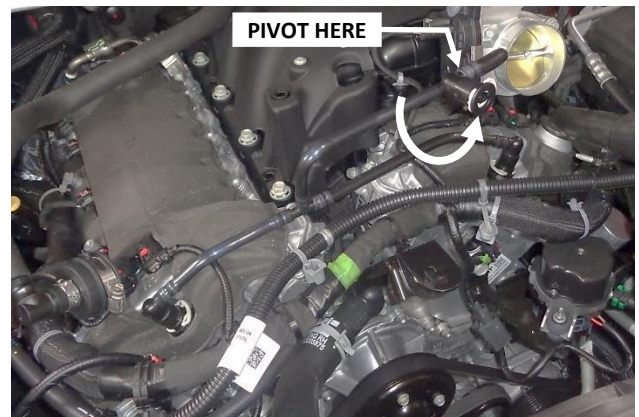

- c. Finally, rotate the PCV fitting so that it faces forward.



29. Install the intake tube in the vehicle. Do not tighten any screw clamps at this time.



30. Rotate the intake tube as necessary to align it with the bracket. Secure the tube to the bracket with an M6 screw (14), lock washer (13) and flat washer (12).

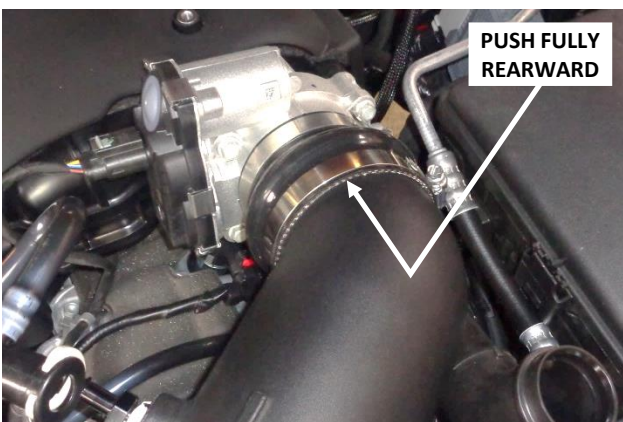

31. Push the reducing coupler back against the throttle body, and tighten only the clamp on the throttle body.

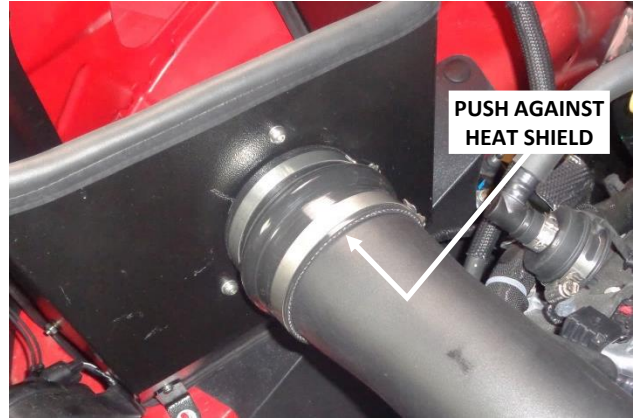

32. Push the large coupler flush up against the heat shield, and tighten the clamp on the heat shield.

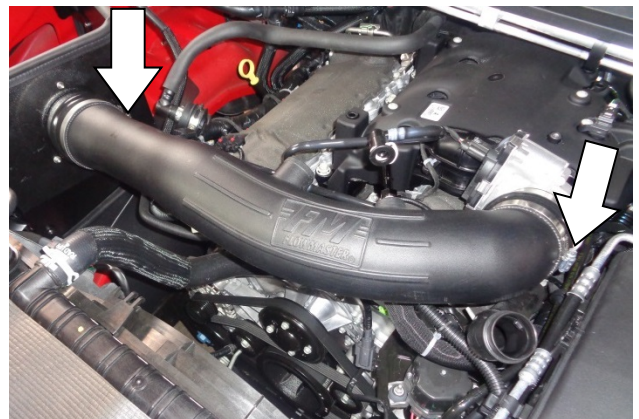

33. Finally, tighten the screw clamps at each end of the intake tube.



34. Connect the PCV line to the quick connect fitting, adjusting the PCV lines as necessary to align them. Verify that the connection is secure.

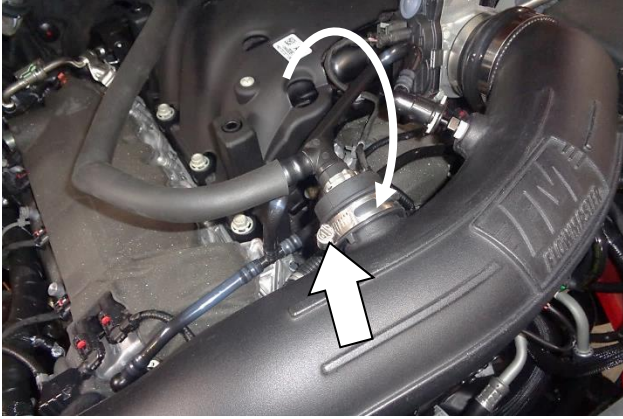

35. Rotate the breather elbow approximately 180 degrees, then connect the breather adaptor to the intake tube using the stock screw clamp.

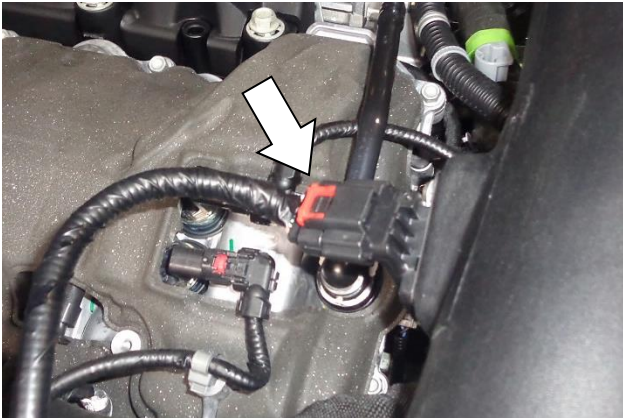

36. Reconnect the MAF sensor plug to the sensor, push the locking tab toward the sensor, and check the plug for security.



37. Place the clamp (2) on the air filter (1), install the filter on the filter adaptor and tighten the clamp.



Congratulations, the installation of your FLOWMASTER cold air intake kit is now complete!