

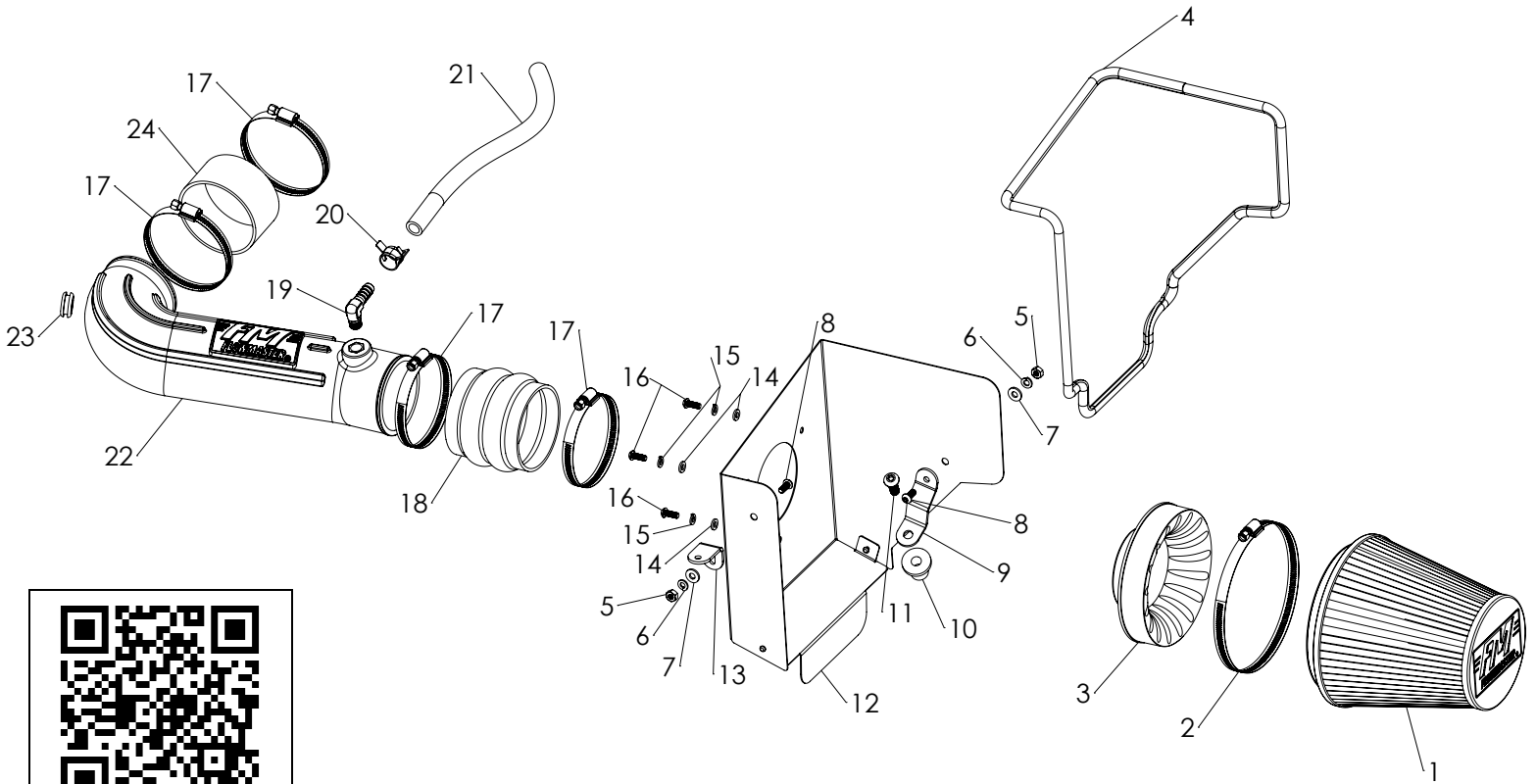

# Installation Instructions for: SYSTEM #615105

2005-2017 Mopar Cars  
5.7L/6.1L Engine

NOT LEGAL FOR SALE OR USE ON ANY POLLUTION-CONTROLLED MOTOR VEHICLE IN CALIFORNIA OR IN STATES THAT HAVE ADOPTED CALIFORNIA EMISSION PROCEDURES.



REV. 8/22/17

ITEM NO.	PART NUMBER	DESCRIPTION	QTY.
1		FILTER, AIR 6.5" HIGH, 6" DIA FLANGE	1
2	AF1002	#104 HOSE CLAMP 4.125 DIA TO 7"	1
3	AF6001	3.5" AIR FILTER ADAPTER	1
4	49000061	PUSH ON VINYL AIR BOX TRIM SEAL	1
5	HW115	1/4"-20 NUT SS	2
6	HW322	1/4" SPLIT LOCK WASHER SS	2
7	HW320	1/4" FLAT WASHER SAE SS	2
8	HW245	1/4"-20 X 5/8" BTNHD SS	2
9	AF5008	11Ga. X 1" BRACKET 2, 615105	1
10	HW119	NUT, BRASS RIVET 3/4" OD RUBBER INSULATED	1
11	HW250	3/8"-16 X 1.125" BTNHD SS	1
12	AF3003	05-16 CHALL/CHAR/300 INTAKE AIRBOX	1

ITEM NO.	PART NUMBER	DESCRIPTION	QTY.
13	AF5007	11Ga. X 1" BRACKET 1, 615105	1
14	HW319	M6 FLAT WASHER SS	3
15	HW318	M6 SPLIT LOCK WASHER SS	3
16	HW244	M6 X 1.0 X 16MM BTNHD SS	3
17	MC350H	#56 HOSE CLAMP 3 1/16 DIA TO 4"	4
18	AF4015	3.5"ID X 3.50"L RUBBER COUPLER, DOUBLE HUMP	1
19	AF4012	1/2" BARB TO 1/4" NPT MALE 90DEG	1
20	MC003P	1/2" HOSE PINCH CLAMP	1
21	49000064	.50" I.D. FUEL HOSE	1
22	AF2003	05-17 MOPAR CARS, 5.7L, 6.1L INTAKE TUBE	1
23	AF4008	GROMMET, RUBBER 1.06"OD X 1/2"ID X 7/16"THK	1
24	AF4007	3.5" X 2"L RUBBER COUPLER, STRAIGHT	1

## Removal:

Note: Please refer to vehicle manufacturer's recommendations regarding removal of components.

1. Turn off the ignition and disconnect the negative battery cable. NOTE: Disconnecting the negative battery cable erases pre-programmed electronic memories. Write down all memory settings before disconnecting the negative battery cable. Some radios will require an anti-theft code to be entered after the battery is reconnected. The anti-theft code is typically supplied with your owner's manual. In the event your vehicles' anti-theft code cannot be recovered, contact an authorized dealership to obtain your vehicles anti-theft code.



2. Carefully disconnect the air temperature sensor connection by depressing the rocking tab on the back of the plug and pulling straight off.



4. Loosen the hose clamp  which secures the factory intake tube to the throttle body. Pull the tube away from throttle body and let it hang in place.



3. Disconnect the crank case vent hose from the stock air-box as shown. **Note:** On some models, the stock hose will be replaced by a longer hose included in the kit. Trim the hose length to avoid kinking the tube and to limit contact with other components .



5. Remove the bolt for the factory air-box on the radiator core support and retain for later use. Remove the entire factory air-box/intake tube assembly by lifting straight up and out. NOTE: We highly recommend that customers retain their factory air intake system.





6. Remove the air temperature sensor from the factory intake tube by prying the clocking tab outward with a flat screwdriver and rotating counter-clockwise as shown.

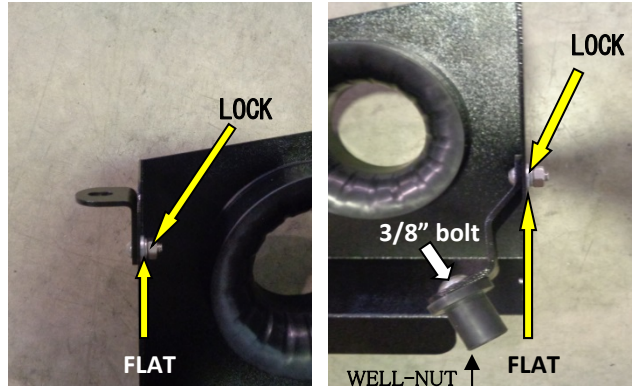

9. Loosely attach the two provided metal brackets to the heat shield using the 1/4" cap screws and corresponding flat and lock washers and the well-nut with corresponding 3/8" bolt as shown.



7. Remove the o-ring from the stock air temperature sensor and lubricate the o-ring area with a small amount of sensor-safe silicone grease or equivalent lubricant. Retain sensor for reinstallation later.

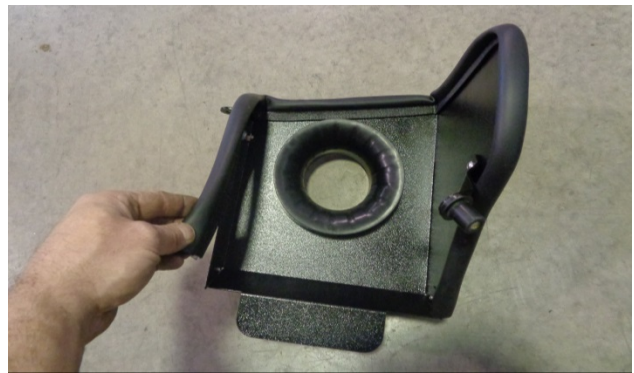

10. Install the rubber trim seal along the outer top and side edges as shown. Press fully into the groove starting from one end. Trim the final length with metal shears for proper fitment.

**Assembly:** Assemble the FM Cold Air Intake using the drawing on the front page for reference.

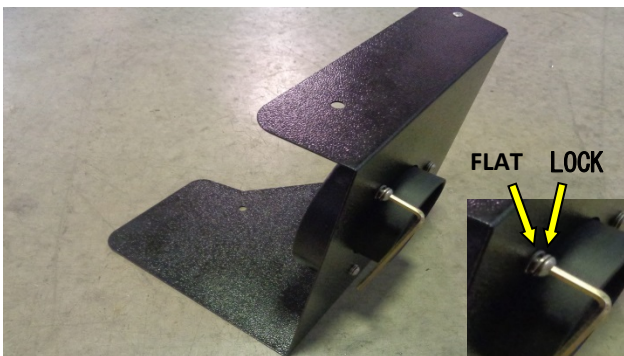

8. Begin by installing the filter adapter onto the heat shield as shown. Fasten with three 6mm screws with flat and locking washers in the sequence shown. Tighten securely but avoid over-torque.



11. Install the heat shield assembly (minus the intake tube and air filter) into the vehicle as shown above with the well-nut expanded tight into the hole on the fender. Reinstall front cross frame bolt and tighten.



12. Loosely assemble the provided silicone-rubber couplers and corresponding hose clamps onto the FM intake tube as shown.

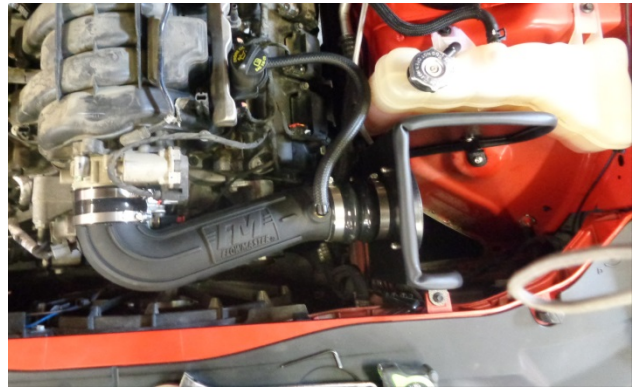

15. Install the FM intake tube assembly onto the air-box and the throttle body. Align and tighten all hose clamps for a satisfactory fit. Attach crankcase vent hose, pinch clamp, and air temperature sensor plug \* (see below).



13. Carefully thread the included 90 degree barbed fitting into the brass threaded insert on the intake tube. **Do not exceed 8 ft/lbs torque; if necessary, apply Teflon thread tape to achieve proper clocking and torque.**



16. \*On some models, the wiring harness may need to be relaxed in order to reach the air temperature sensor. This is accomplished by gently prying the plastic dart-clamp  out of its hole.



14. Install the included rubber grommet into the hole on the FM intake tube elbow and insert the air temperature sensor to the fully-seated position as shown by twisting clockwise and pressing inward.



17. Secure the provided cone filter using the included hose clamp in the desired position. Recheck torque on all fasteners and clamps, reinstall the engine cover and reattach the negative battery cable. Enjoy!