



## Programmable 8 Channel Injector Driver Module 554-142

### Overview:

The 8 channel fuel injector driver module allows for an input signal from any ECU to be changed into a user selectable peak and hold current. The selectable peak and hold currents allow for the user to select the most ideal setting based on the battery voltage, fuel pressure and specific injector used.

### Injector Driver Basic Function:

This injector driver module uses a common “peak and hold” current methodology. Basic operation is such that the driver will allow for a certain current level to be reached when an injector is opened. Under normal circumstances, when this current is met, the injector should be fully open. At this time the driver will reduce the current to a lower “hold” current level, as to not overheat the injector. It is possible, depending on the resistance of the injector and battery voltage, that the peak current level cannot be reached. If this occurs, the driver will maintain this current for 5 milliseconds and then reduce to the hold current. To determine how much current an injector can draw, use the following calculation. Use a volt/ohm meter to measure the resistance of the injector (put the probes across the injector with the meter set to measure resistance)

Current = System Voltage/Injector Coil Resistance

For example:

Current = 13.8 volts/2 Ohms  
= 6.9 Amps

In this case, this injector, at 13.8 volts would not draw enough current to reach an 8 Amp setting.

If the battery voltage was increased to 16.5 volts it would however:

16.5 volts/2 Ohms = 8.25 Amps

The module allows for the user to select different operation settings. These settings are:

- “Peak Current” – This is the amount of supply current the driver will limit to when the injector is opening. Depending on the injector resistance and battery voltage, this current may or may not be reached. If this current is not reached, the peak current will time-out after 5 milliseconds. This will also set a fault.
- “Peak Current Hold Time” – This is the amount of time the Peak Current is held, after the Peak Current is reached. The injector pintle should be fully open by the time the Peak Current is reached, however the current can be held after this current is reached for a short time, to ensure injector opening if the pintle hasn't opened fully at this point.

# Injector Driver Setup:

## User Configuration

The 8 channel fuel injector driver module has user configurable settings that can be adjusted by a set of DIP switches concealed behind an access door on the bottom of the enclosure. The DIP switches come pre-set to position 7 (8A Peak/2A Hold W/ long peak duration). Other than the 10A settings, this setting is the “most aggressive” setting in terms of applying current to make sure the injector is open. The dip switches are under a cover that can be removed with four screws on the back of the unit.









### DIP Switch Configuration

To change the configuration set by the DIP switches a specific sequence must be followed.

- 1) Remove rear cover on the back of the unit.
- 2) Power on unit.
- 3) Set the DIP switch to the desired position.
- 4) Hold the pushbutton next to the DIP switch for a minimum of 10 seconds.

Configuration of the unit can only occur provided no injector pulses have been seen since the previous power cycle. This will prevent an accidental reconfiguration during operation. Additionally, the adjacent momentary pushbutton switch must be pressed and held continuously for at least 10 seconds to store a new configuration. At this point, the unit’s LEDs will flash the Configuration Number 3 times in Green on the Indicator LEDs to indicate that a new configuration was stored.

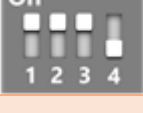
The configuration options that can be set are as follows:

Configuration Number	DIP Switches	Setting
1		4A Peak / 1A Hold Short Peak Duration (0.5ms)
2		6A Peak / 1.5A Hold Short Peak Duration (0.5ms)
3		8A Peak / 2A Hold Short Peak Duration (0.5ms)
4		10A Peak / 2.5A Hold Short Peak Duration (0.5ms)
5		4A Peak / 1A Hold Long Peak Duration (1ms)
6		6A Peak / 1.5A Hold Long Peak Duration (1ms)
7 (DEFAULT)		8A Peak / 2A Hold Long Peak Duration (1ms)
8		10A Peak / 2.5A Hold Long Peak Duration (1ms)
9 .. 15		Reserved
16		Enter Test Sequence (see Test Sequence section of instructions)

Selecting the Right Settings:

Common injectors and their settings:

Injector	Configuration Number
Holley 160 (522-168)	1
Holley 220 (522-228)	1
Billet Atomizer 160-245	3
Billet Atomizer 325-800	7
Precision 500	7

If your injector is not listed you can still calculate an approximate peak current needed. You will need to use a multimeter to check resistance across one of your injectors and also know the voltage that your injectors will be run at. Once you know or have a good idea of both voltage and resistance (Ohms) you can divide them together to come up with your approximate amperage requirements.

Example: 13.8 volts divided by 1.7 ohms = 8.1 amps

## LED Behavior

The 8 channel injector driver includes 8 RGB LEDs to display various information. During normal operation the LEDs will display the status of their associated injector channel, while following power on or the storage of a new configuration, they will flash codes to indicate the stored configuration settings. At any time, the LEDs may also indicate a fault if one is detected. Fault reporting is further explained later in these instructions. Faults will be shown at the first key-on after they have occurred and can be logged to an ECU as well.



Behavior of the LEDs during operation is as follows:

Condition	LED (1...8)
Normal Operation	Solid Green
No Injector Pulses for > 1s (following first pulse)	Solid Yellow
Channel Fault Detected	Solid Red
Global Fault Detected (e.g., wiring fault)	All LEDs Solid Red
Idle/Unused	Off

On startup, the LED associated with the current stored configuration (1 – 8) will flash Green 3 times.

## Test Sequence

A special test sequence is included in the design to allow for a quick test of injector operation in the field. To limit the potential damage from misuse of the test sequence, operation is limited to 5 seconds total.

The test sequence is triggered by applying a specific configuration setting using the DIP switches on the unit, and holding down the configuration button continuously for at least 10 seconds. Once triggered, all 8 injectors will fire sequentially for 5 one-second cycles (4ms ON time each cycle) with the stored configuration settings, after which the test sequence will stop and normal operation will resume. As with other configuration changes, the test sequence can only be initiated provided no injector pulses have been sent to the module since the last power cycle. Multiple test sequences can be initiated without a power cycle, but require pressing and holding the configuration button for 10s each time.

Once the test is performed, move the dip switch back to desired setting. Performing the test sequence does NOT change what the configuration setting is, so it does not have to be re-programmed, but it does no harm to do so.

## Fault Handling

The injector module is capable of detecting a number of fault conditions, either at power up or during operation:

Fault	Description
<b>Under voltage</b>	Input voltage dropped to < 6V during operation (likely indicating a wiring issue)
<b>Over voltage</b>	Input voltage exceeded 34V during operation
<b>Output Shorted to Battery</b>	Injector output is short-circuited to battery (peak current > 15A)
<b>Output Open Load</b>	Peak output current is < 25% of target value
<b>Thermal Shutdown</b>	Driver overheated and was forced to turn off fast demagnetization. Slow demagnetization enabled to retain functionality.
<b>Wiring Fault</b>	A wiring fault has been detected on the I/O connector (e.g., +12V_OUT has been shorted to GND)
<b>No Configuration Found</b>	No stored configuration found in memory. In the case of this fault to reduce risk of engine damage, the unit will default to configuration #7.
<b>Injector Power Not Present</b>	The injector driver includes two power connections, one large gauge 2-pin connector for high current and another on the 34 Pin connector for switched power. The device monitors for the presence of the large gauge power connection and, if it is not present, will shut down operation until the next power cycle to prevent damage.
<b>Injector Not Hitting Peak Current</b>	The injector current is monitored and a fault is raised if the peak current is not reached in a certain amount of time. This fault is not stored over a power cycle.

## Fault Output Signals

### FAULT OUTPUT (Pin 2)

The fault output signal is a low-side drive output that will activate whenever a fault is detected. It is suggested that users hook this up to a ground input on their EFI and/or to a “fault light” for diagnostic purposes. The fault output will activate for a minimum of 10ms after which it will remain active if the fault persists. Once the fault has cleared, the output deactivate until another fault occurs.

### FAULT CODE OUTPUT (Pin 23)

The fault code output signal is 0 – 5V analog voltage output that provides more details about a fault after the fault output (pin 2) has activated. The fault code output will send two pulses, each 100ms long. The 1<sup>st</sup> pulse will indicate the type of fault that was detected, and the 2<sup>nd</sup> will indicate the channel that it occurred on (if applicable). Connect this to a 0-5V/analog input on the ECU. Encoding of the signals is as follows:

Fault Type (1 <sup>st</sup> pulse)		
Fault Code Voltage	Fault Number	Fault Type
0.5V	1	Thermal Shutdown
1.0V	2	Undervoltage Fault
1.5V	3	Overvoltage Fault
2.0V	4	Output Shorted to Battery
2.5V	5	Output Open Load
3.0V	6	No Configuration Found
3.5V	7	Injector Power Not Present
4.0V	8	Wiring Fault
4.5V	9	Injector Not Hitting Peak Current

Fault Channel	
Fault Code Voltage	Channel
0.5V	1
1.0V	2
1.5V	3
2.0V	4
2.5V	5
3.0V	6
3.5V	7
4.0V	8

Fault pulse pairs will be separated by a 5V pulse marker in between to help differentiate different faults.

### Stored Faults

The Injector Module will store the latest fault for diagnostic use, and will retain the fault over a single power cycle. On startup, once the unit has flashed the stored configuration, it will flash the stored fault code if it exists. The Fault Number will be flashed first in Red, followed by the Fault Channel (if applicable) in Blue. At any time during this sequence, if an injector pulse is received the LEDs will revert to their normal operating behavior.

**Note:** the Injector Not Hitting Peak fault is not stored, and will not be displayed on startup, but will be output on the fault outputs as it occurs.

## Pinout

### 2-Pin Power

The 2-pin power uses the same power connector as Holley EFI ECU's. (Positive on left when looking at connector on device with latch on top).

- Ground is on Pin A
- Batt+ is on Pin B

### 34-Pin Connector

Pin Number	Signal	Pin Number	Signal
1	Injector #1 Output	18	Injector #3 Output
2	Fault Switched Output	19	
3		20	
4	Injector #6 Input	21	
5	Injector #7 Input	22	
6	Injector #8 Input	23	Fault Analog/Code Output
7		24	CANH
8	Low-Drive Configuration	25	Injector #7 Output
9	Injector #5 Output	26	Injector #4 Output
10	Injector #2 Output	27	Injector #1 Input
11	+12V_SWITCHED	28	Injector #2 Input
12		29	Injector #3 Input
13		30	Input Drive Configuration
14		31	Injector #4 Input
15		32	CANL
16	High-Side Drive Configuration	33	Injector #5 Input
17	Injector #6 Output	34	Injector #8 Output

## Wiring

Wiring is supplied with the 554-142 that allows wiring from a Holley EFI HP/Dominator ECU to the injector driver module and from the injector driver box to an injector harness. A metripak 150 crimper will be needed to install the supplied injector connector. The injector driver module uses the same connector and pin type that the HP and Dominator ECU uses. Wires are supplied that have the proper pins pre-crimped on them. If these are shortened, loose pins are included to re-terminate these wires. A Holley PN 567-100 crimping tool can be used for this.

There are two likely wiring scenarios that will be performed using a Holley EFI ECU on an 8 cylinder engine. The first will cover using the driver module with eight injector driver outputs. The second will cover the use of the driver box when using the four secondary injector drivers on a Dominator ECU.

### Wiring Size

Individual Injector Trigger Wire - The wiring supplied for individual injector triggers is 18 gauge. 20 gauge is usually adequate, but with some of the more aggressive current settings, it is better to use larger wire.

Injector Power Feed - The user must supply wire for injector power. There is no harm in using larger gauge wire. It is recommended to use a 10-14 gauge wire, split into two 18 gauge wires (as short as possible) at the 10 pin metripak connector. Use a minimum of a 40A relay to power a set of 8 injectors. The injector power is NOT supplied or run through the injector driver box.

### Supplied Wiring Components:

#### Loose Wires

Qty	Length	Component	Terminations	Use
1	6'	18 Ga Black Wire	Terminal/Terminal	ECU to Driver Module
1	6'	18 Ga Black Wire	Terminal/Cut	Driver Module to Injector Harness
1	6'	18 Ga Blue Wire	Terminal/Terminal	ECU to Driver Module
1	6'	18 Ga Blue Wire	Terminal/Cut	Driver Module to Injector Harness
1	6'	18 Ga Grey Wire	Terminal/Terminal	ECU to Driver Module
1	6'	18 Ga Grey Wire	Terminal/Cut	Driver Module to Injector Harness
1	6'	18 Ga Green Wire	Terminal/Terminal	ECU to Driver Module
1	6'	18 Ga Green Wire	Terminal/Cut	Driver Module to Injector Harness
1	6'	18 Ga Yellow Wire	Terminal/Terminal	ECU to Driver Module
1	6'	18 Ga Yellow Wire	Terminal/Cut	Driver Module to Injector Harness
1	6'	18 Ga Brown Wire	Terminal/Terminal	ECU to Driver Module
1	6'	18 Ga Brown Wire	Terminal/Cut	Driver Module to Injector Harness
1	6'	18 Ga Purple Wire	Terminal/Terminal	ECU to Driver Module
1	6'	18 Ga Purple Wire	Terminal/Cut	Driver Module to Injector Harness
1	6'	18 Ga Orange Wire	Terminal/Terminal	ECU to Driver Module
1	6'	18 Ga Orange Wire	Terminal/Cut	Driver Module to Injector Harness
1	6'	20 Ga Red/White	Terminal/Cut	Must be installed in Pin 11
1	4"	20 Ga White	Terminal/Terminal	Must be installed per instructions

## Components

Qty		Component		Use
15		Cavity Plug		Install in open connector cavities
12		Loose Terminals (bagged)		Use for re-terminations if needed
1		Module Connector		Populate with proper wires
1		Bagged Injector Connector/Pins/Seals/TPA		Used to assemble new Injector Connection

## Main Power Harness

Qty		Component		Use
1		Main Power/Ground		Main Power/Ground for Module

**Required Wires!! – The following are REQUIRED connections. These are in addition to the injector input and output wires. These are NOT indicated on the injector wiring diagrams below.**

Injector Driver Module Power Harness – An injector driver module power harness is supplied. This should be connected to battery power and ground. A fuse can be added if desired. Use a 30A fuse if installed. The red wire goes to battery power and the black to ground. Make sure you do NOT short the power to ground, or damage may result. Terminals and heat shrink are supplied. **REQUIRED CONNECTION**

Switched Power Wire – The included 20 ga red/white wire needs to be installed in pin #11. This should be run to a switched ignition power source. This draws less than 1 Amp. **REQUIRED CONNECTION**

Injector Drive Configuration Jumper – The included 4” white jumper wire must be installed in one of the two configuration methods (**ONE REQUIRED**):

“Low Side Driven Injector Drivers” – EFI systems, which include any Holley EFI system, where the ECU triggers the injectors with a ground (meaning the injectors have a constant battery power feed), need to connect the white wire jumper from pin #8 to pin #30.

“High Side Driven Injector Drivers” – If the EFI system triggers the injectors with a 12v/battery voltage signal (meaning the injectors have a constant ground applied), need to connect the white jumper wire from pin #16 to pin #30.

## Optional Wires:

Switched Fault Output – Pin 2 – This is a ground output (connect to a ground input on an ECU) that will activate whenever a fault is detected. See the fault output signal area for more information. This can be datalogged.

Analog Fault Output – Pin 23 – This is a 0-5V analog output voltage (connect to a 0-5V analog input on an ECU) that provides more detail when a fault occurs. See the fault output signal area for more information. This can be datalogged.



## Wiring Scenario 1 – Eight injector inputs in and eight out to injectors

This scenario would be when using eight injector outputs on the Holley EFI J1B connector (either HP or Dominator ECUs) or any ECU with eight injector triggers on a V8 engine. The eight ECU outputs simply go into the eight driver box inputs, and eight outputs are run to the injectors. See Diagram 1 below.

NOTE: See the REQUIRED WIRES section for other required wires!

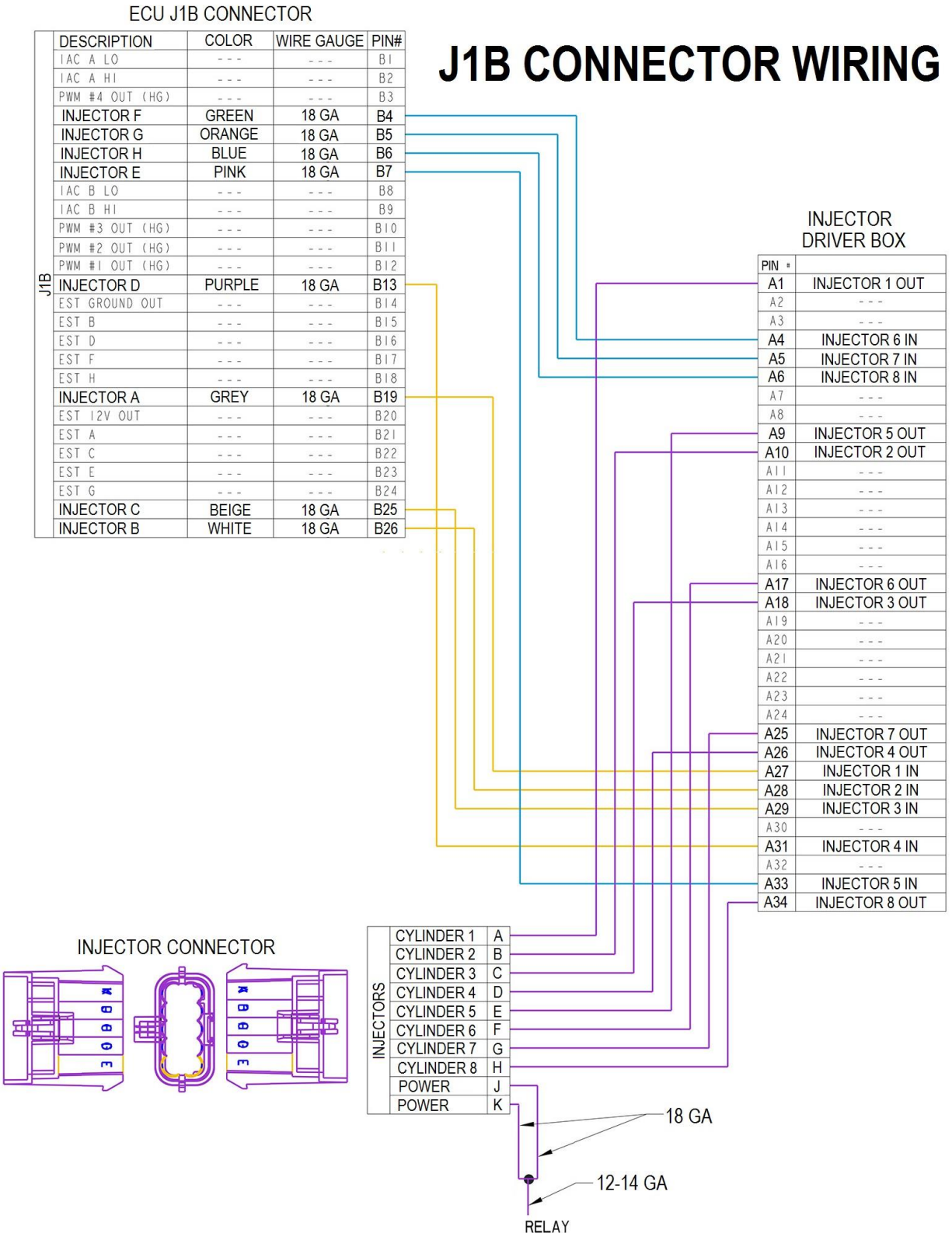

Diagram 1

## Wiring Scenario 2 – 4 injector drivers split into eight inputs in and eight out

This scenario would be used when using the four injector outputs on a Holley Dominator ECU to drive eight injectors (driven by the injector driver module). The four ECU outputs need to be split/spliced into two wires. See Diagrams 2 (Ford) & 3 (GMC). These diagrams are dependent on the firing order of the engine, and different diagrams are shown.

NOTE: See the REQUIRED WIRES section for other required wires!

### J2B CONNECTOR

INJECTOR	PIN#
---	B1
---	B2
---	B3
---	B4
---	B5
---	B6
INJECTOR J	B7
---	B8
---	B9
---	B10
---	B11
---	B12
INJECTOR K	B13
---	B14
---	B15
---	B16
---	B17
---	B18
INJECTOR L	B19
---	B20
---	B21
---	B22
---	B23
---	B24
---	B25
INJECTOR I	B26

# J2B CONNECTOR WIRING

FOR FIRING ORDERS 1-3-7-2-6-5-4-8 (302 H.O./351W)

### INJECTOR DRIVER BOX

PIN#	
A1	INJECTOR 1 OUT
A2	---
A3	---
A4	INJECTOR 6 IN
A5	INJECTOR 7 IN
A6	INJECTOR 8 IN
A7	---
A8	---
A9	INJECTOR 5 OUT
A10	INJECTOR 2 OUT
A11	---
A12	---
A13	---
A14	---
A15	---
A16	---
A17	INJECTOR 6 OUT
A18	INJECTOR 3 OUT
A19	---
A20	---
A21	---
A22	---
A23	---
A24	---
A25	INJECTOR 7 OUT
A26	INJECTOR 4 OUT
A27	INJECTOR 1 IN
A28	INJECTOR 2 IN
A29	INJECTOR 3 IN
A30	---
A31	INJECTOR 4 IN
A32	---
A33	INJECTOR 5 IN
A34	INJECTOR 8 OUT

NOTE: " • " DENOTES SPLICE

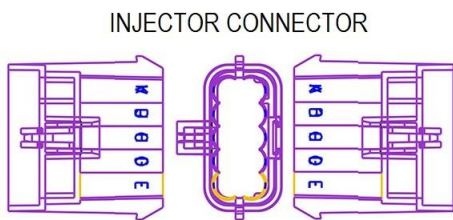

### INJECTOR CONNECTOR

INJECTORS	
CYLINDER 1	A
CYLINDER 2	B
CYLINDER 3	C
CYLINDER 4	D
CYLINDER 5	E
CYLINDER 6	F
CYLINDER 7	G
CYLINDER 8	H
POWER	J
POWER	K

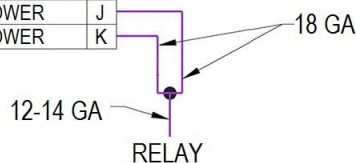

Diagram 2 – Ford

J2B CONNECTOR

INJECTOR	PIN#
---	B1
---	B2
---	B3
---	B4
---	B5
---	B6
INJECTOR J	B7
---	B8
---	B9
---	B10
---	B11
---	B12
INJECTOR K	B13
---	B14
---	B15
---	B16
---	B17
---	B18
INJECTOR L	B19
---	B20
---	B21
---	B22
---	B23
---	B24
---	B25
INJECTOR I	B26

# J2B CONNECTOR WIRING

FOR FIRING ORDERS:  
 1-8-4-3-6-5-7-2 (STD. GM)  
 1-8-7-3-6-5-4-2 (4/7 SWAP)  
 1-8-7-2-6-5-4-3 (LS)

NOTE: " • " DENOTES SPLICE

INJECTOR DRIVER BOX

PIN#	
A1	INJECTOR 1 OUT
A2	---
A3	---
A4	INJECTOR 6 IN
A5	INJECTOR 7 IN
A6	INJECTOR 8 IN
A7	---
A8	---
A9	INJECTOR 5 OUT
A10	INJECTOR 2 OUT
A11	---
A12	---
A13	---
A14	---
A15	---
A16	---
A17	INJECTOR 6 OUT
A18	INJECTOR 3 OUT
A19	---
A20	---
A21	---
A22	---
A23	---
A24	---
A25	INJECTOR 7 OUT
A26	INJECTOR 4 OUT
A27	INJECTOR 1 IN
A28	INJECTOR 2 IN
A29	INJECTOR 3 IN
A30	---
A31	INJECTOR 4 IN
A32	---
A33	INJECTOR 5 IN
A34	INJECTOR 8 OUT

INJECTOR CONNECTOR

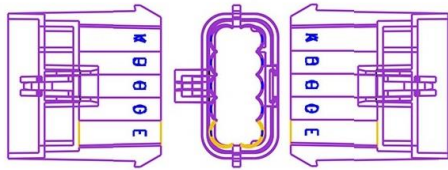

INJECTORS	
CYLINDER 1	A
CYLINDER 2	B
CYLINDER 3	C
CYLINDER 4	D
CYLINDER 5	E
CYLINDER 6	F
CYLINDER 7	G
CYLINDER 8	H
POWER	J
POWER	K

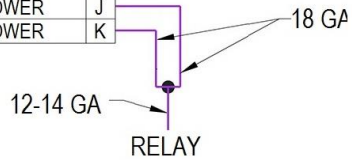

Diagram 3 – GM

**199R11287**  
**Date: 10-10-17**